

EVS-1000/1100 USER

Intel® Xeon®/Core™ i7/i5/i3 Fanless GPU Computing System with
NVIDIA® Quadro® MXM, PCI/PCIe Expansion

Manual

Record of Revision

Version	Date	Page	Description	Remark
1.0	03/01/2018	All	Official Release	
1.1	04/24/2018	iv	Update	
1.2	11/06/2018	All	Update	
1.3	10/07/2020	39	Update	
1.4	08/04/2021	All	Update	
1.5	08/08/2022	All	Update	
1.6	04/10/2022	102, 103, 104	Update	
1.7	06/05/2023	8, 95	Update	

Disclaimer

This manual is released by Vecow Co., Ltd. for reference purpose only. All product offerings and specifications are subject to change without prior notice. It does not represent commitment of Vecow Co., Ltd. Vecow shall not be liable for direct, indirect, special, incidental, or consequential damages arising out of the use of the product or documentation or any infringements upon the rights of third parties, which may result from such use.

Declaration of Conformity

FCC This equipment has been tested and found to comply with the limits for a Class A digital device, pursuant to part 15 of the FCC Rules. These limits are designed to provide reasonable protection against harmful interference when the equipment is operated in a commercial environment. This equipment generates, uses, and can radiate radio frequency energy, and if it is not installed and used in accordance with the instruction manual, it may cause harmful interference to radio communications. Operation of this equipment in a residential area is likely to cause harmful interference in which case the user will be required to correct the interference at his own expense.

CE The products described in this manual complies with all applicable European Union (CE) directives if it has a CE marking. For computer systems to remain CE compliant, only CE-compliant parts may be used. Maintaining CE compliance also requires proper cable and cabling techniques.

Copyright and Trademarks

This document contains proprietary information protected by copyright. No part of this publication may be reproduced in any form or by any means, electric, photocopying, recording or otherwise, without prior written authorization by Vecow Co., Ltd. The rights of all the brand names, product names, and trademarks belong to their respective owners.

Order Information

Part Number	Description
EVS-1010	EVS-1000, NVIDIA® Quadro® MXM, 2 GigE LAN, 1 PCIe x4, 6 USB 3.0, 4 COM, 3 SIM, 32 Isolated DIO
EVS-1001	EVS-1000, NVIDIA® Quadro® MXM, 2 GigE LAN, 1 PCI, 6 USB 3.0, 4 COM, 3 SIM, 32 Isolated DIO
EVS-1110	EVS-1100, NVIDIA® Quadro® MXM, 2 GigE LAN, 1 PCIe x4, 6 USB 3.0, 3 COM, 3 SIM, 32 Isolated DIO
EVS-1101	EVS-1100, NVIDIA® Quadro® MXM, 2 GigE LAN, 1 PCI, 6 USB 3.0, 3 COM, 3 SIM, 32 Isolated DIO

Order Accessories

Part Number	Description
E3-1268L v5	6th Gen Intel® Xeon® E3-1268L v5 Processor (8M Cache, up to 3.40GHz, 35W)
i7-7700T	7th Gen Intel® Core™ i7-7700T Processor (8M Cache, up to 3.80GHz, 35W)
i7-6700TE	6th Gen Intel® Core™ i7-6700TE Processor (8M Cache, up to 3.40GHz)
i5-7500T	7th Gen Intel® Core™ i5-7500T Processor (6M Cache, up to 3.30GHz, 35W)
i5-6500TE	6th Gen Intel® Core™ i5-6500TE Processor (6M Cache, up to 3.30GHz)
i3-7101TE	7th Gen Intel® Core™ i3-7101TE Processor (3M Cache, up to 3.40GHz, 35W)
i3-6100TE	6th Gen Intel® Core™ i3-6100TE Processor (4M Cache, 2.70GHz)
DDR4 32G	Certified DDR4 32GB 2666MHz RAM
DDR4 16G	Certified DDR4 16GB 2400/2133 MHz RAM
DDR4 8G	Certified DDR4 8GB 2400/2133 MHz RAM
DDR4 4G	Certified DDR4 4GB 2400/2133 MHz RAM
PWA-280W-WT	280W, 24V, 85V AC to 264V AC Power Adaptor with 3-pin Terminal Block, Wide Temperature -30°C to +70°C
PWA-160W-WT	160W, 24V, 85V AC to 264V AC Power Adaptor with 3-pin Terminal Block, Wide Temperature -30°C to +70°C
PWA-120W	120W, 24V, 90V AC to 264V AC Power Adapter
VESA Mount	VESA Mounting Kit
DIN-RAIL Kit	DIN Rail and VESA Mounting Kit
Rack Mount	2U Rackmount Kit
TMK2-20P-100	Terminal Block 20-pin to Terminal Block 20-pin Cable, 100cm
TMK2-20P-500	Terminal Block 20-pin to Terminal Block 20-pin Cable, 500cm
TMB-TMBK-20P	Terminal Board with One 20-pin Terminal Block Connector and DIN-Rail Mounting
4G Module	Mini PCIe 4G/GPS Module with Antenna
WiFi & Bluetooth	WiFi & Bluetooth Module with Antenna

Table of Contents

CHAPTER 1	GENERAL INTRODUCTION	1
1.1	Overview	1
1.2	Features	2
1.3	Product Specification	2
1.3.1	Specifications of EVS-1000	2
1.3.2	Specifications of EVS-1100	4
1.4	Supported CPU List	6
1.5	Mechanical Dimension	7
1.5.1	Dimensions of EVS-1000	7
1.5.2	Dimensions of EVS-1100	7
CHAPTER 2	GETTING TO KNOW YOUR EVS-1000/1100	8
2.1	Packing List	8
2.1.1	Packing List of EVS-1000	8
2.1.2	Packing List of EVS-1100	8
2.2	Front Panel I/O & Functions	9
2.3	Rear Panel I/O & Functions	17
2.4	Main Board Expansion Connectors	24
2.5	Main Board Jumper and DIP Switch Settings	35
2.6	Ignition Control	39
CHAPTER 3	SYSTEM SETUP	42
3.1	How to Open Your EVS-1000/1100	42
3.2	Installing CPU	47

3.3	Installing DDR4 SO-DIMM Modules	49
3.4	Installing Mini PCIe Card	50
3.5	Installing Antenna Cable	51
3.6	Installing CFast Card	53
3.7	Installing SIM Card	54
3.8	Installing PCI/PCIe Card	55
3.9	Installing SSD/HDD	57
3.10	Mounting Your EVS-1000/1100	59
CHAPTER 4	BIOS AND DRIVER	64
4.1	BIOS Settings	64
4.2	Main	65
4.3	Advanced	65
4.4	Chipset	76
4.5	Security	81
4.6	Boot	83
4.7	Save & Exit	84
APPENDIX A	Isolated DIO Guide	85
APPENDIX B	Software Functions	90
APPENDIX C	RAID Installation Guide	93
APPENDIX D	Supported Memory & Storage List	98
APPENDIX E	Graphics Benchmark	101
APPENDIX F	Install Win11 (BIOS TPM Setting)	102

1

GENERAL INTRODUCTION

1.1 Overview

Vecow EVS-1000 Series is a high-performance, Fanless Embedded GPU Computing System. Powered by workstation-grade 7th generation Intel® Xeon®/Core™ i series processor (Kaby Lake-S/Skylake-S) with Intel® C236 chipset, compact NVIDIA® Quadro® MXM graphics engine, advanced NVIDIA® Turing™ architecture supporting up to 8K resolution and 7 independent HD displays. Vecow EVS-1000/1100 delivers not only up to 144% enhanced system performance but 1295% enhanced graphics performance than the one without additional graphics engine; multiple PCIe 3.0 (8GT/s), SATA III (6Gbps), USB 3.0 (5Gbps) and multiple wireless connections deliver seamless high-speed data conveying. Vecow EVS-1000 series Fanless GPU Computing system makes all-in-one Small Form Factor Fanless GPU Computing solution possible.

Featuring up to 8 display interfaces, 2 front-access 2.5" SSD trays, 2-port GigE LAN supporting iAMT 11.0, 1 CFast, 3 external SIM sockets for WiFi, 4G, 3G, LTE, GPRS or UMTS, 6 USB 3.0 sockets and 4 COM RS-232/422/485; onboard PCI/PCIe slot for multiple 10 GigE LAN, PoE+, GigE LAN, LAN Bypass, or USB 3.0 expansions, optional SUMIT A, B slot supports additional multiple 10 GigE LAN, SIM sockets, GigE fiber LAN or GigE LAN; 32 Isolated DIO, 10V to 36V DC power input with 80V surge protection, configuration ignition power control, remote power switch, EN50155, EN50121-3-2 compliant, industrial-grade reliability, all-in-one integrated features, Vecow EVS-1000 Series Fanless GPU Computing System serves outstanding system performance, versatile I/O functions, flexible expansions, and rugged reliability for Industrial AI applications.

With leading system performance, all-in-one integrated features, smart manageability, flexible expandability, mobile availability, and rugged reliability, Vecow EVS-1000 Series Fanless GPU Computing System is your smart solution for Deep Learning, Robot Control, Autonomous Vehicle, Telemedicine, Machine Vision, Intelligent Surveillance and any AI-oriented Industry 4.0/IIoT embedded applications.

1.2 Features

- LGA 1151 Socket supports workstation-grade 7th Generation Intel® Xeon®/Core™ i7/i5/i3 Processor (Kaby Lake/Skylake) with Intel® C236 Chipset
- Compact NVIDIA® Quadro® MXM graphics engine supports NVIDIA® Turing™ GPU architecture, up to 8K resolution
- Fanless, -25°C to 60°C Operating Temperature
- 2 DDR4 2400/2133 MHz Memory, up to 64GB
- Display : 1 VGA, 1 DVI, and 6 DisplayPort, up to 7 independent HD displays
- 2 Independent GigE LAN support iAMT 11.0
- 3 SIM card sockets for WiFi/4G/3G/LTE/GPRS/UMTS
- Storage : 2 Front-access 2.5" SSD Tray, 1 CFast Socket, 2 SATA III
- 32 Isolated DIO, 6 USB 3.0, 4 COM RS-232/422/485
- Expansion : 1 PCI/PCIe Slot, 3 Mini PCIe/mSATA, optional SUMIT A, B
- 10V to 36V DC power input, 80V Surge Protection
- Configurable Ignition Power Control

1.3 Product Specification

1.3.1 Specifications of EVS-1000

System	
Processor	Quad Core Intel® Xeon®/Core™ i7/i5/i3 Processor (Kaby Lake-S/Skylake-S)
Chipset	Intel® C236
BIOS	AMI
SIO	IT8786E
Memory	<ul style="list-style-type: none"> • DDR4 2400/2133 MHz • Up to 64GB • 2 260-pin SO-DIMM Socket
I/O Interface	
Serial	4 COM RS-232/422/485 with auto flow control (ESD 8KV)
USB	<ul style="list-style-type: none"> • 6 External USB 3.0 (4 Front, 2 Rear) • 1 USB 2.0 (Internal)
Isolated DIO	32 Isolated DIO : 16 DI, 16 DO)
LED	Power, HDD, Wireless
SIM Card	3 External SIM Card Socket
Expansion	
Mini PCIe	3 Full-size for PCIe/USB/External SIM Card/mSATA
PCI/PCIe	1 PCIe x4 Slot
SUMIT A, B	2 SUMIT Slot (Optional)

Graphics	
Graphics Processor	<ul style="list-style-type: none"> • Intel® HD Graphics 630/P530/530 • Independent MXM Graphics : By request • MXM Graphics TDP : 50W
Interface	8 Display interfaces : <ul style="list-style-type: none"> • 1 DVI : Up to 1920 x 1200 @ 60Hz • 1 VGA : Up to 1920 x 1200 @ 60Hz • 2 DisplayPort : Up to 4096 x 2304 @ 60Hz • 4 DisplayPort : Up to 7680 x 4320 @ 60Hz
Storage	
SATA	2 SATA III (6Gbps) support software RAID 0, 1
mSATA	3 SATA III (Mini PCIe Type, 6Gbps)
Storage Device	<ul style="list-style-type: none"> • 1 CFast Socket, Push-in/Push-out Ejector • 2 Front-access 2.5" SSD/HDD Tray
Audio	
Audio Codec	Realtek ALC892, 5.1 Channel HD Audio
Audio Interface	1 Mic-in, 1 Line-out
Ethernet	
LAN 1	Intel® I219LM GigE LAN supports iAMT 11.0
LAN 2	Intel® I210 GigE LAN
Power	
Input Voltage	10V to 36V, DC-in
Power Interface	3-pin Terminal Block : V+, V-, Frame Ground
Ignition Control	16 Mode (Internal)
Remote Switch	3-pin Terminal Block : On, Off, IGN
Surge Protection	Up to 80V/1ms Transient Power
Others	
TPM	Optional Infineon SLB9665 supports TPM 2.0, LPC interface
Watchdog Timer	Reset : 1 to 255 sec./min. per step
Smart Management	Wake on LAN, PXE supported
HW Monitor	Monitoring temperature, voltages. Auto throttling control when CPU overheats.
Software Support	
OS	Windows 10, Windows 8.1, Windows 7, Linux
Mechanical	
Dimension (W x D x H)	260mm x 215mm x 79mm (10.2" x 8.5" x 3.1")
Weight	4.6 kg (10.14 lb)

Mounting	<ul style="list-style-type: none"> • Wallmount by mounting bracket • DIN Rail Mount • 2U Rackmount (Optional)
Environment	
Operating Temperature	-25°C to 60°C (-13°F to 140°F)
Storage Temperature	-40°C to 85°C (-40°F to 185°F)
Humidity	5% to 95% humidity, non-condensing
Relative Humidity	95% at 60°C
Shock	IEC 60068-2-27 SSD : 50G @ wallmount, Half-sine, 11ms
Vibration	IEC 60068-2-64 SSD : 5Grms, 5Hz to 500Hz, 3 Axis
EMC	CE, FCC, EN50155, EN50121-3-2

1.3.2 Specifications of EVS-1100

System	
Processor	Quad Core Intel® Xeon®/Core™ i7/i5/i3 Processor (Kaby Lake-S/Skylake-S)
Chipset	Intel® C236
BIOS	AMI
SIO	IT8786E
Memory	<ul style="list-style-type: none"> • DDR4 2400/2133 MHz • Up to 64GB • 2 260-pin SO-DIMM Socket
I/O Interface	
Serial	4 COM RS-232/422/485 with auto flow control (ESD 8KV)
USB	<ul style="list-style-type: none"> • 6 External USB 3.0 (4 Front, 2 Rear) • 1 USB 2.0 (Internal)
Isolated DIO	32 Isolated DIO : 16 DI, 16 DO)
LED	Power, HDD, Wireless
SIM Card	3 External SIM Card Socket
Expansion	
Mini PCIe	3 Full-size for PCIe/USB/External SIM Card/mSATA
PCI/PCIe	1 PCIe x4 Slot
SUMIT A, B	2 SUMIT Slot (Optional)

Graphics	
Graphics Processor	<ul style="list-style-type: none"> • Intel® HD Graphics 630/530 • Independent MXM Graphics : By request • MXM Graphics TDP : 50W to 110W
Interface	8 Display interfaces : <ul style="list-style-type: none"> • 1 DVI : Up to 1920 x 1200 @ 60Hz • 1 VGA : Up to 1920 x 1200 @ 60Hz • 2 DisplayPort : Up to 4096 x 2304 @ 60Hz • 4 DisplayPort : Up to 7680 x 4320 @ 60Hz
Storage	
SATA	2 SATA III (6Gbps) support software RAID 0, 1
mSATA	3 SATA III (Mini PCIe Type, 6Gbps)
Storage Device	<ul style="list-style-type: none"> • 1 CFast Socket, Push-in/Push-out Ejector • 2 Front-access 2.5" SSD/HDD Tray
Audio	
Audio Codec	Realtek ALC892, 5.1 Channel HD Audio
Audio Interface	1 Mic-in, 1 Line-out
Ethernet	
LAN 1	Intel® I219LM GigE LAN supports iAMT 11.0
LAN 2	Intel® I210 GigE LAN
Power	
Input Voltage	with 50W GPU: 10V to 36V, DC-in with 80W to 110W GPU : 16V to 36V, DC-in
Power Interface	3-pin Terminal Block : V+, V-, Frame Ground
Ignition Control	16 Mode (Internal)
Remote Switch	3-pin Terminal Block : On, Off, IGN
Surge Protection	Up to 80V/1ms Transient Power
Others	
TPM	Optional Infineon SLB9665 supports TPM 2.0, LPC interface
Watchdog Timer	Reset : 1 to 255 sec./min. per step
Smart Management	Wake on LAN, PXE supported
HW Monitor	Monitoring temperature, voltages. Auto throttling control when CPU overheats.
Software Support	
OS	Windows 10, Windows 8.1, Windows 7, Linux
Mechanical	
Dimension (W x D x H)	260mm x 215mm x 115mm (10.2" x 8.5" x 4.5")
Weight	5.1 kg (11.24 lb)

Mounting	<ul style="list-style-type: none"> • Wallmount by mounting bracket • DIN Rail Mount • 2U Rackmount (Optional)
Environment	
Operating Temperature	-25°C to 60°C (-13°F to 140°F)
Storage Temperature	-40°C to 85°C (-40°F to 185°F)
Humidity	5% to 95% humidity, non-condensing
Relative Humidity	95% at 60°C
Shock	IEC 60068-2-27 SSD : 50G @ wallmount, Half-sine, 11ms
Vibration	IEC 60068-2-64 SSD : 5Grms, 5Hz to 500Hz, 3 Axis
EMC	CE, FCC, EN50155, EN50121-3-2

1.4 Supported CPU List

Processor No.	TDP	Cache	Max. Frequency	Embedded
Xeon® E3-1268L v5	15W	4M	Up to 3.90GHz	Yes
Core™ i7-7700T	35W	8M	Up to 3.80GHz	Yes
Core™ i7-6700TE	35W	8M	Up to 3.40GHz	Yes
Core™ i5-7500T	35W	6M	Up to 3.30GHz	Yes
Core™ i5-6500TE	35W	6M	Up to 3.30GHz	Yes
Core™ i3-7101TE	35W	3M	Up to 3.40GHz	Yes
Core™ i3-6100TE	35W	4M	Up to 2.70GHz	Yes

1.5 Mechanical Dimension

1.5.1 Dimensions of EVS-1000

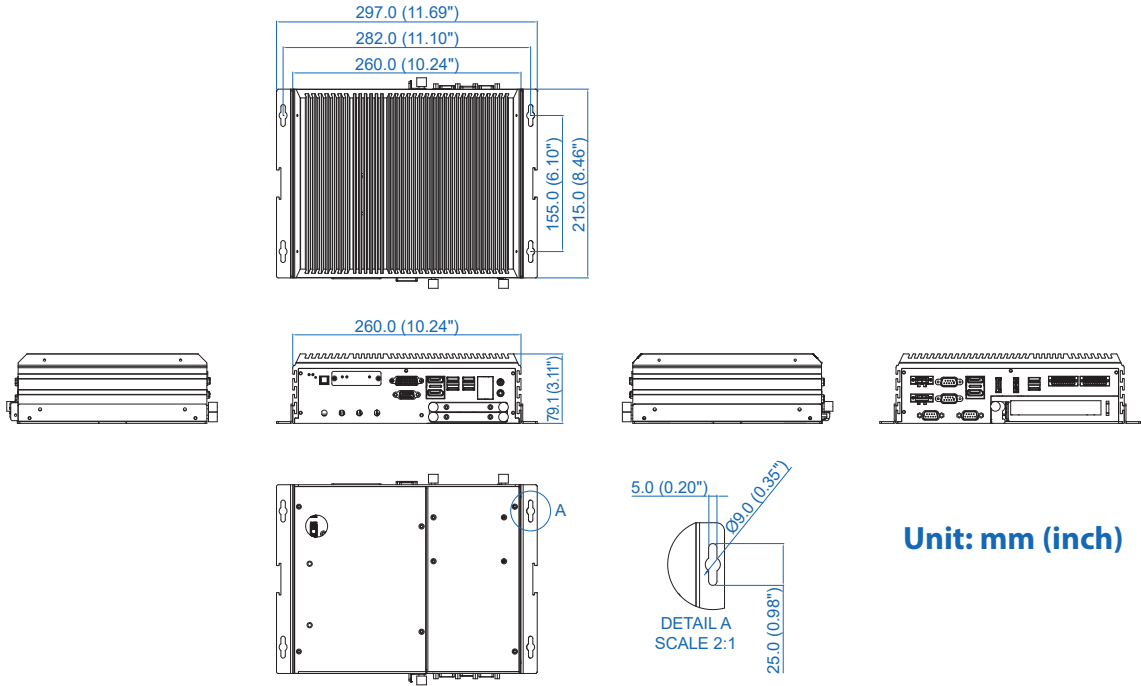

1.5.2 Dimensions of EVS-1100

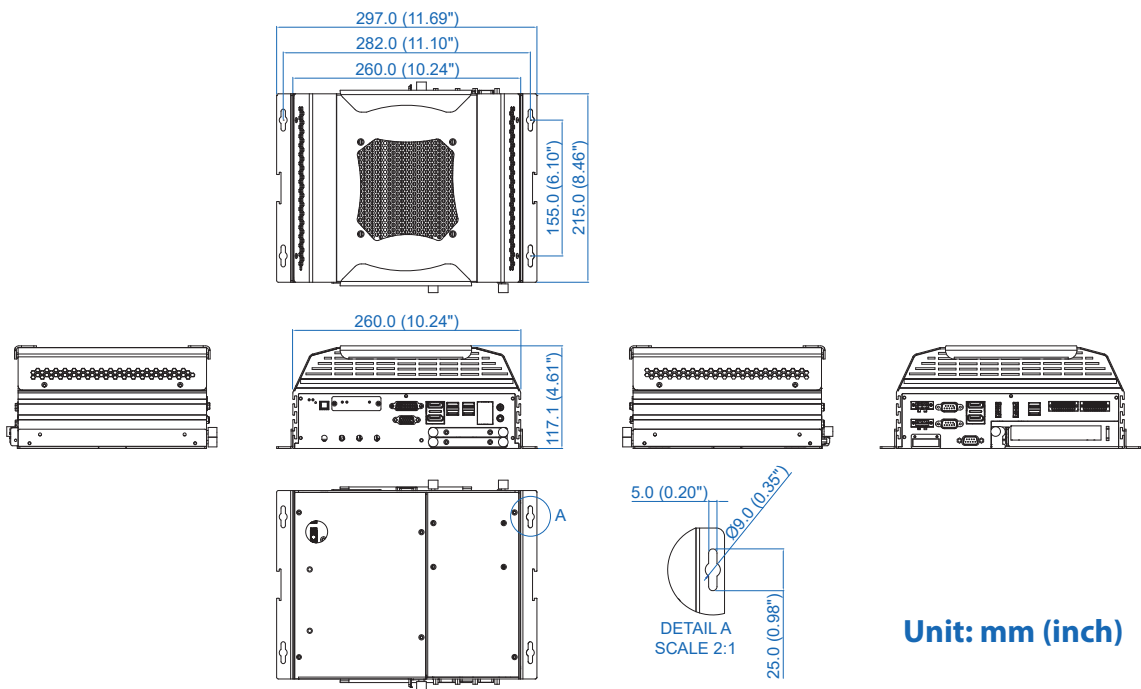

2

GETTING TO KNOW YOUR EVS-1000/1100

2.1 Packing List

2.1.1 Packing List of EVS-1000

Item	Description	Qty
1	EVS-1000 Expandable Fanless Embedded System (According to the configuration you order, the EVS-1000 series may contain SSD/HDD and DDR4 SO-DIMM. Please verify these items if necessary.)	1
2	EVS-1000-Accessory box, which contains <ul style="list-style-type: none">• Wall-mounting bracket• KHS#6-32x6 screw for wall-mounting bracket• M2.5x6 screw for Mini PCIe Slot• Din-Rail-PH-M4x16.5-S Ni• M3x11 Spring screw for CPU• 3-pin pluggable terminal block• 20-pin pluggable terminal block• Foot Pad• F-M3x4 for SSD/HDD screws	2 4 3 4 4 2 2 4 4

2.1.2 Packing List of EVS-1100

Item	Description	Qty
1	EVS-1100 Expandable Embedded System (According to the configuration you order, the EVS-1100 series may contain SSD/HDD and DDR4 SO-DIMM. Please verify these items if necessary.)	1
2	EVS-1100-Accessory box, which contains <ul style="list-style-type: none">• Wall-mounting bracket• KHS#6-32x6 screw for wall-mounting bracket• M2.5x6 screw for Mini PCIe Slot• Din-Rail-PH-M4x16.5-S Ni• M3x11 Spring screw for CPU• 3-pin pluggable terminal block• 20-pin pluggable terminal block• Foot Pad• F-M3x4 for SSD/HDD screws	2 4 3 4 4 2 2 4 4

2.2 Front Panel I/O & Functions

In Vecow EVS-1000 series family, all I/O connectors are located on front panel and rear panel. Most of the general connections to computer device, such as USB, LAN Jack, Audio, Display, VGA, DVI-D and any additional storage, are placed on the front panel.

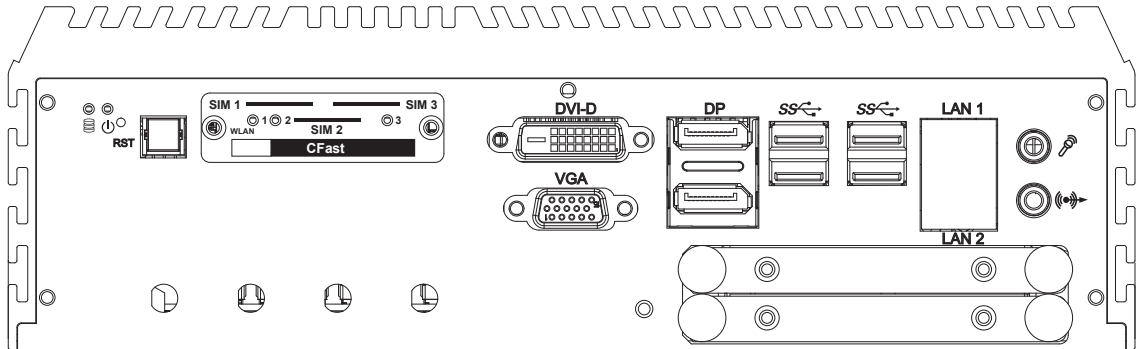

2.2.1 Power Button

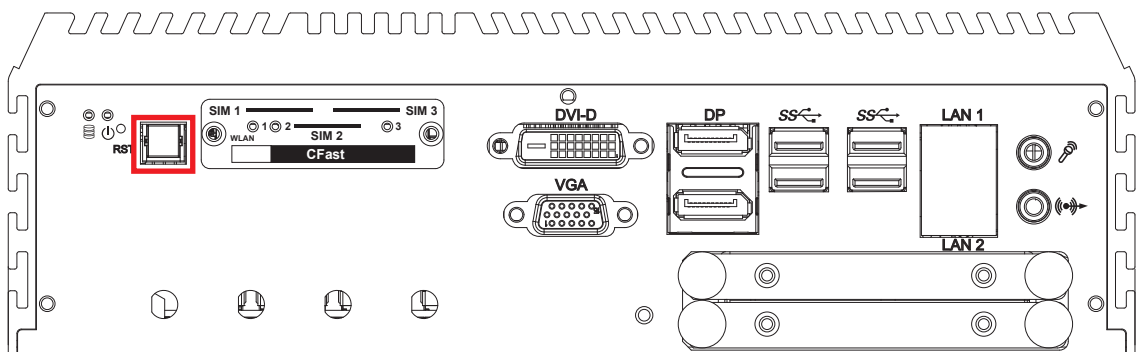

The Power Button is a non-latched switch with dual color LED indication. It indicates power status : S0, S3 and S5. More detail LED indications are listed as follows :

LED Color	Power Status	System Status
Solid Blue	S0	System working
Solid Orange	S3, S5	Suspend to RAM, System off with standby power

To power on the system, press the power button and then the blue LED is lightened. To power off the system, you can either command shutdown by OS operation, or just simply press the power button.

If system error, you can just press the power button for 4 seconds to shut down the machine directly. Please do note that a 4-second interval between each 2 power-on/power-off operation is necessary in normal working status. (For example, once turning off the system, you have to wait for 4 seconds to initiate another power-on operation.)

2.2.2 Reset Tact Switch

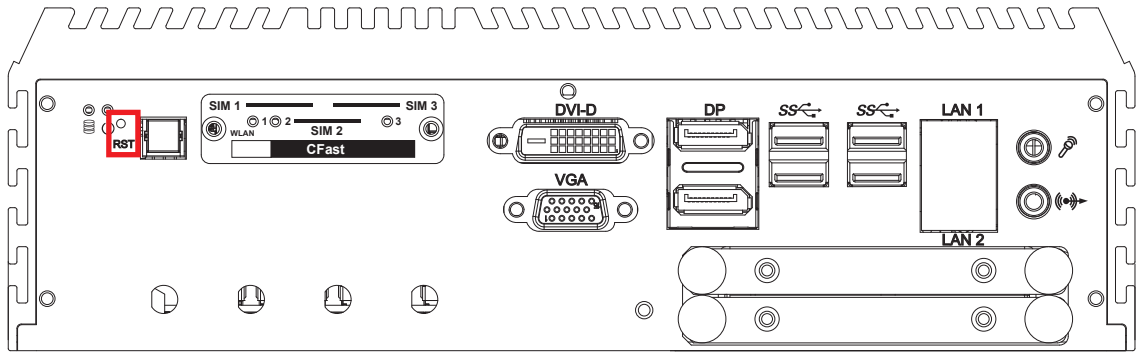

It is a hardware reset switch. Use this switch to reset the system without power off the system. Press the Reset Switch for a few seconds, and then reset will be enabled.

2.2.3 CFast Card

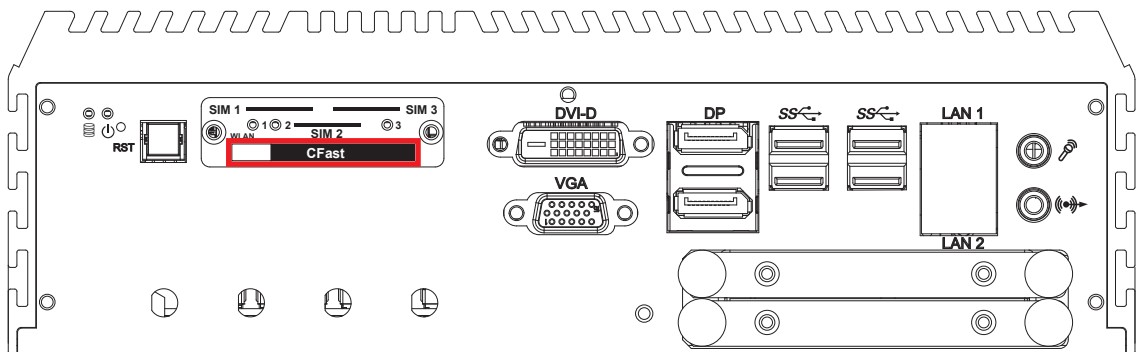

There is a CFast socket on the front panel supporting Type-I/II Compact Flash card. It is implemented by a SATA III Port from C236 PCH. Be sure to disconnect the power source and unscrew the CFast socket cover before installing a CFast card. The EVS-1000/1100 does not support the CFast hot swap and PnP (Plug and Play) functions. It is necessary to remove power source first before inserting or removing the CFast card.

The pinouts of CFast port are listed as follows :

Pin No.	Description	Pin No.	Description
S1	GND	PC6	NC
S2	SATA_TX20	PC7	GND
S3	SATA_TX#20	PC8	CFAST_LED
S4	GND	PC9	NC
S5	SATA_RX#20	PC10	NC
S6	SATA_RX20	PC11	NC

Pin No.	Description	Pin No.	Description
S7	GND	PC12	NC
PC1	GND	PC13	+3.3V
PC2	GND	PC14	+3.3V
PC3	NC	PC15	GND
PC4	NC	PC16	GND
PC5	NC	PC17	NC

2.2.4 PWR & HDD LED Indicator

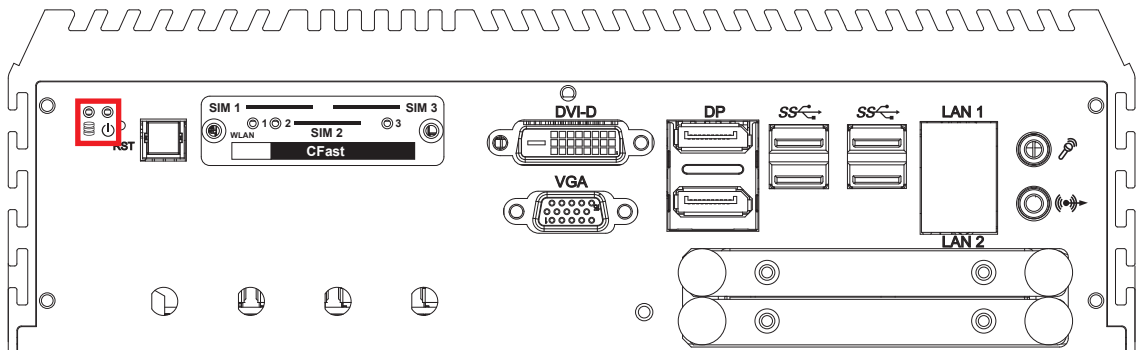

HDD LED/Yellow : A Hard Disk/CFast LED. If the LED is on, it indicates that the system's storage is functional. If it is off, it indicates that the system's storage is not functional. If it is flashing, it indicates data access activities.

Power LED/Green : If the LED is solid green, it indicates that the system is powered on.

LED Color	Indication	System Status
Yellow	HDD/CFast	<ul style="list-style-type: none"> On/Off : Storage status, function or not Twinkling : Data transferring
Green	Power	System power status (On/Off)

2.2.5 DVI-D Connector

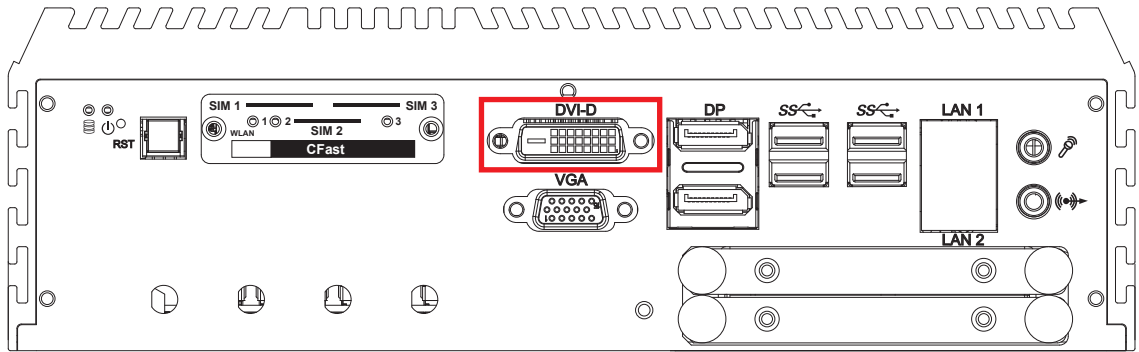

The DVI-D connector on the front panel supports DVI display. This connector can either output DVI signal. The DVI output mode supports up to 1920 x 1200 resolution and output mode supports up to 1920 x 1200 resolution. The DVI is automatically selected according to the connected display. You will need a DVI-D cable when connecting to a display device.

2.2.6 VGA Connector

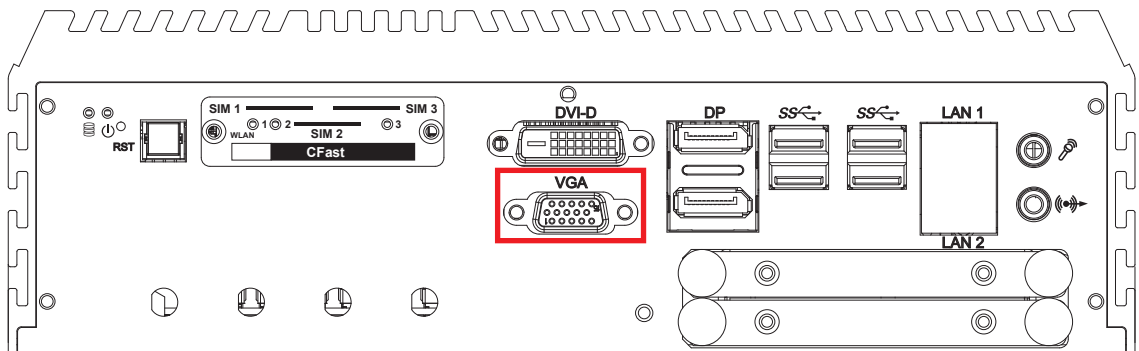

The VGA output mode supports up to 1920 x1200 resolution. The pin assignments of the VGA connector are shown below.

Pin No.	Description	Pin No.	Description
1	Red Color Signal	9	VCC
2	Green Color Signal	10	Ground
3	Blue Color Signal	11	NC
4	NC	12	DDC-DATA
5	Ground	13	H-Sync.
6	VGA Detect	14	V-Sync.
7	Ground	15	DDC-CLK
8	Ground		

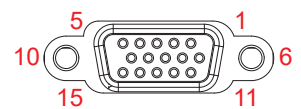

2.2.7 DisplayPort

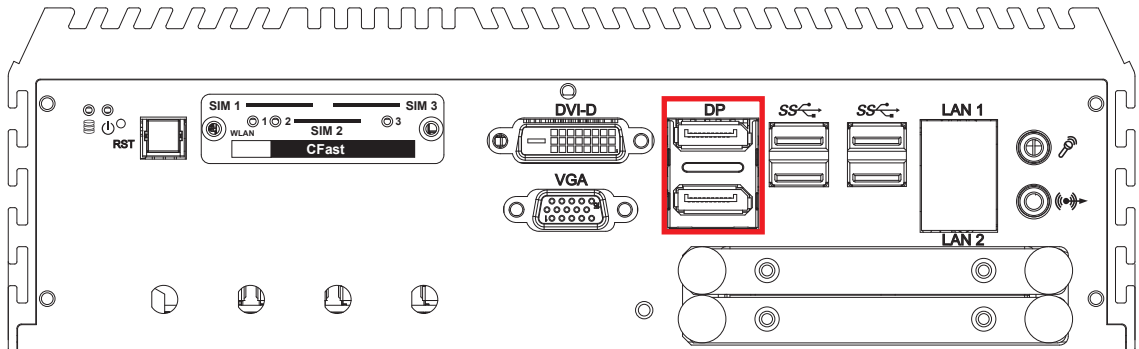

Onboard Display Port supports auxiliary channel dual mode, and the connection supports up to 4096 x 2304 resolution at 60Hz.

Multi-Stream Transport Display Resolutions Table :

Multi-Stream Transport Display	Max. Resolution
Two panel displays concurrently	4096 x 2304 @60Hz

2.2.8 USB 3.0

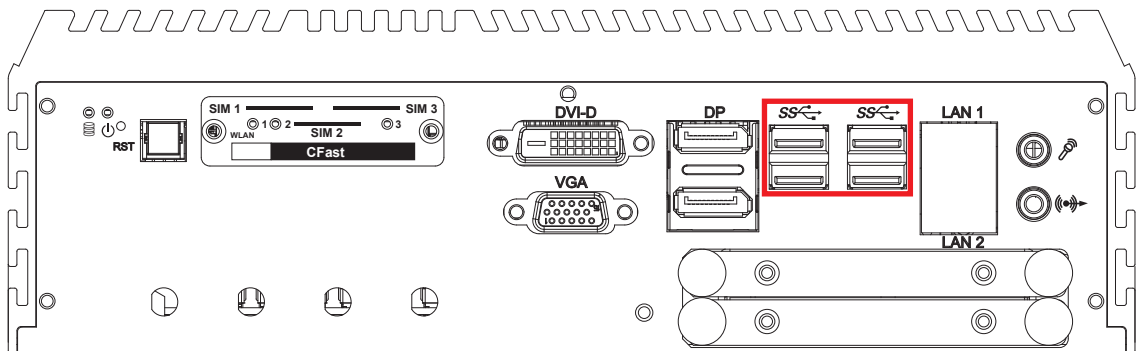

There are 4 USB 3.0 connections available supporting up to 5GB per second data rate in the front side of EVS-1000/1100. It is also compliant with the requirements of Speed (SS), High Speed (HS), Full Speed (FS) and Low Speed (LS).

2.2.9 Ethernet Port

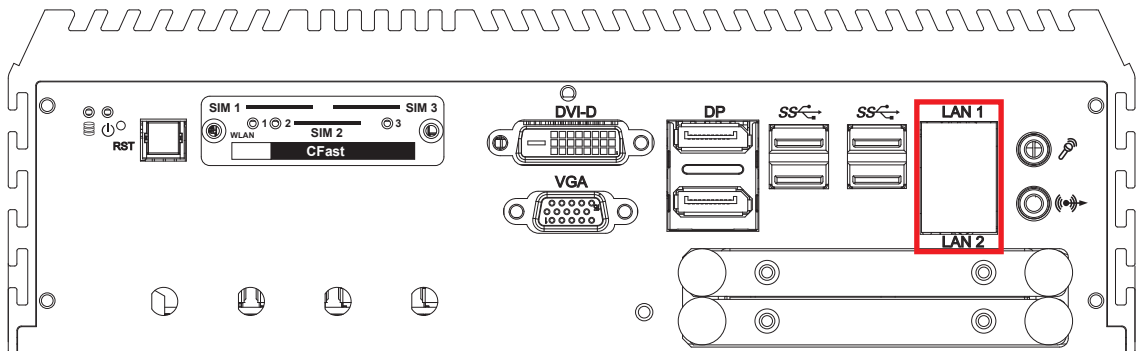

There are dual 8-pin RJ-45 jacks supporting 10/100/1000 Mbps Ethernet connections in the front side. LAN 1 is powered by Intel I219 Ethernet Phy and LAN 2 is powered by Intel I210 Ethernet engine. When both LAN 1 and LAN 2 work at normal status, iAMT 11.0 function is enabled.

Using suitable RJ-45 cable, you can connect the system to a computer or to any other devices with Ethernet connection; for example, a hub or a switch. Moreover, both LAN 1 and LAN 2 support Wake on LAN and Pre-boot functions. The pin-outs of LAN 1 and LAN 2 are listed as follows :

Pin No.	10/100 Mbps	1000Mbps
1	E_TX+	MDI0_P
2	E_TX-	MDI0_N
3	E_RX+	MDI1_P
4	-	MDI2_P
5	-	MDI2_N
6	E_RX-	MDI1_N
7	-	MDI3_P
8	-	MDI3_N

Each LAN port is supported by standard RJ-45 connector with LED indicators to present Active/Link/Speed status of the connection.

The LED indicator on the right bottom corner lightens in solid green when the cable is properly connected to a 100Mbps Ethernet network; The LED indicator on the right bottom corner lightens in solid orange when the cable is properly connected to a 1000Mbps Ethernet network; The left LED will keep twinkling/off when Ethernet data packets are being transmitted/received.

	10Mbps	100Mbps	1000Mbps
Right	Off	Solid Green	Solid Orange
Bottom LED	Flash Yellow	Flash Yellow	Flash Yellow

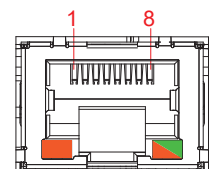

2.2.10 Audio Jack

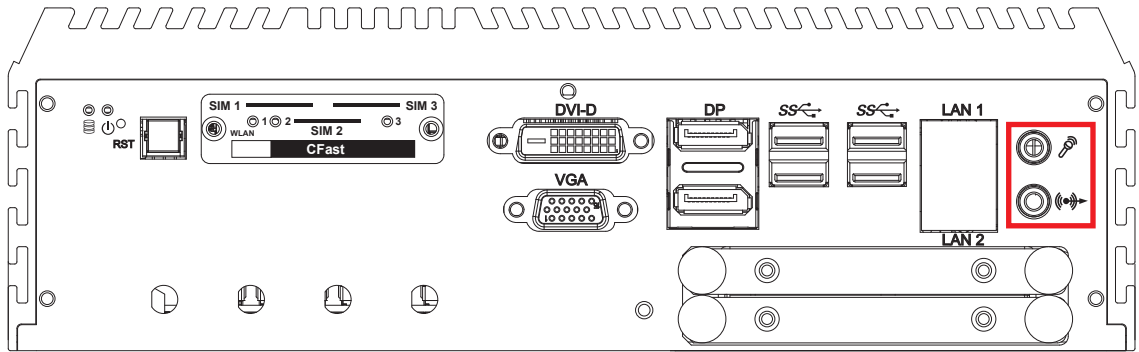

There are 2 audio connectors, Mic-in and Line-out, in the front side of EVS-1000/1100. Onboard Realtek ALC892 audio codec supports 5.1 channel HD audio and fully complies with Intel® High Definition Audio (Azalia) specifications.

To utilize the audio function in Windows platform, you need to install the corresponding drivers for both Intel CM236 chipset and Realtek ALC892 codec.

2.2.11 WLAN LED, Mini PCIe, SIM Card Comparison

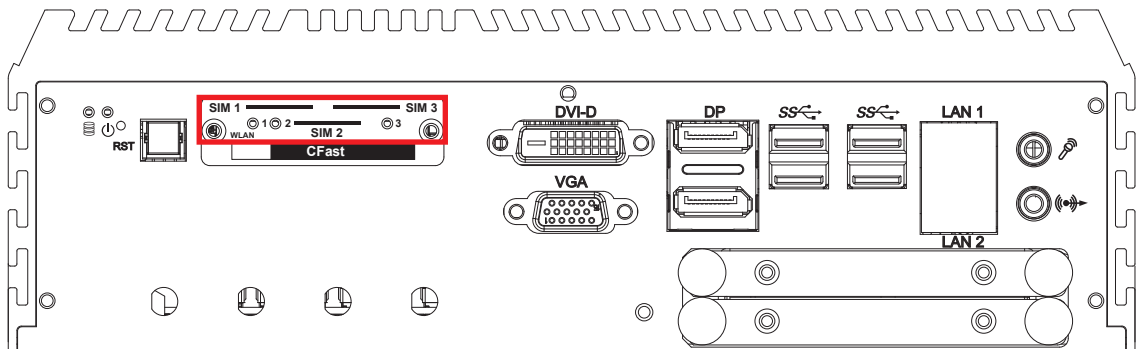

Mini PCIe Slot/SIM Slot/WLAN LED Mapping Table :

Mini PCIe	SIM	LED
Mini PCIe 1	SIM 1 (CN14)	MPCIE1_LED1
Mini PCIe 2	SIM 2 (CN15)	MPCIE2_LED1
Mini PCIe 3	SIM 3 (CN16)	MPCIE3_LED1

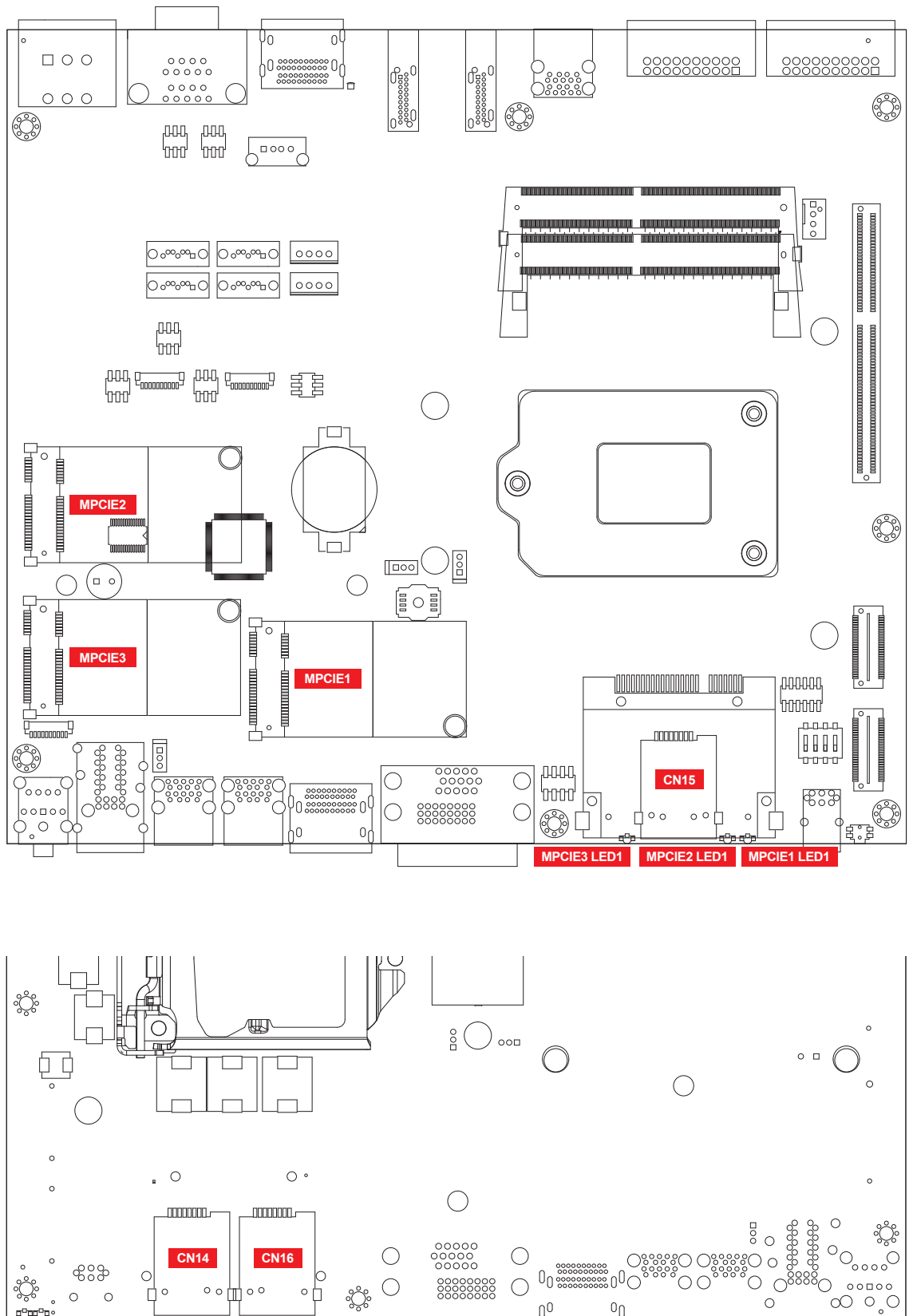

The SIM card sockets do not support hot-plug. Please make sure to unplug the system power before inserting the SIM card (s).

2.2.12 SSD/HDD Tray

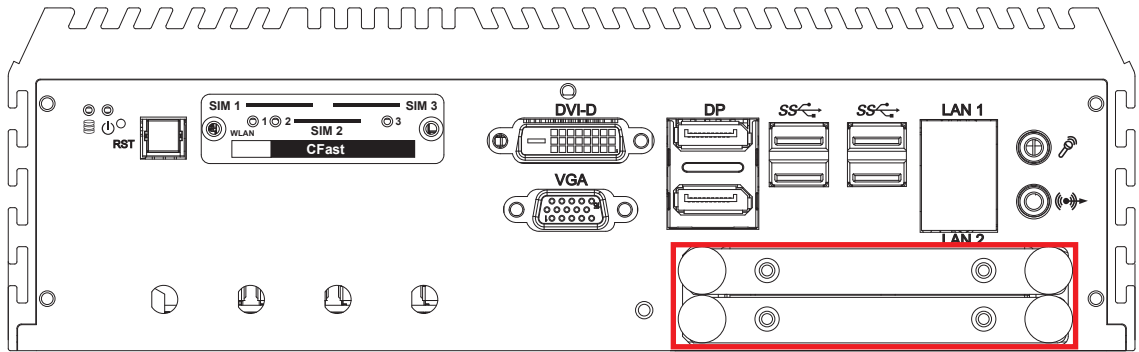

There are 2 front-access 2.5" SSD/HDD trays in the front side of EVS-1000/1100. Just trigger to open the SSD/HDD tray, up to 4TB is available.

2.3 Rear Panel I/O & Functions

2.3.1 Power Terminal Block

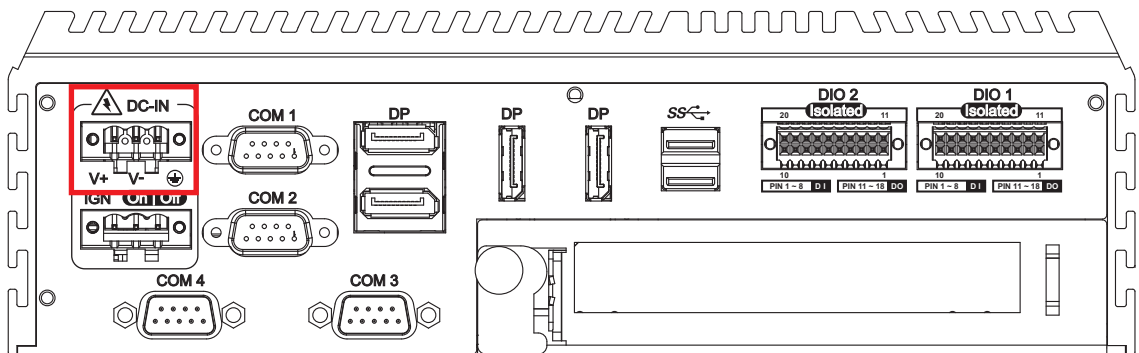

This system supports 10V to 36V DC power input by terminal block in the rear side. In normal power operation, power LED lightens in solid green. It supports up to 80V surge protection.

Pin No.	Definition
1	V+
2	V-
3	Chassis Ground

2.3.2 Remote Power On/Off Switch & Ignition

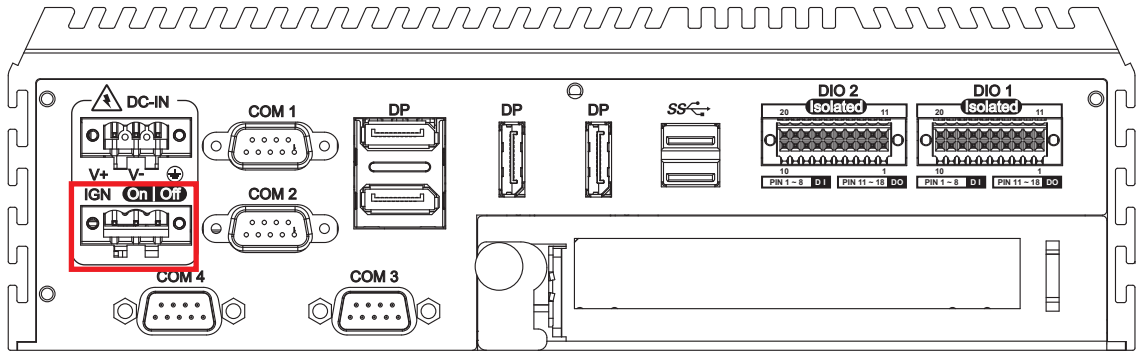

It is a 2-pin power-on or power-off switch through Phoenix Contact terminal block. You could turn on or off the system power by using this contact. This terminal block supports dual functions of soft power-on/power-off (instant off or delay 4 second) and suspend mode.

Pin No.	Definition
1	Ignition
2	External Power Button V+
3	External Power Button V-

2.3.3 COM Ports

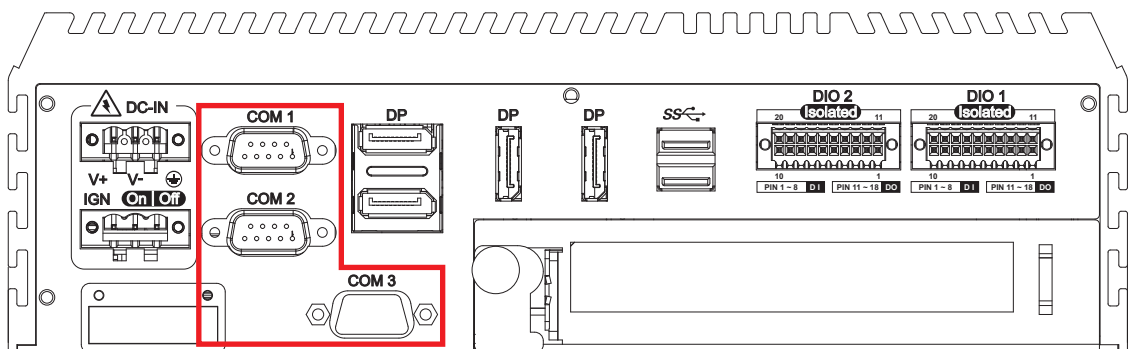
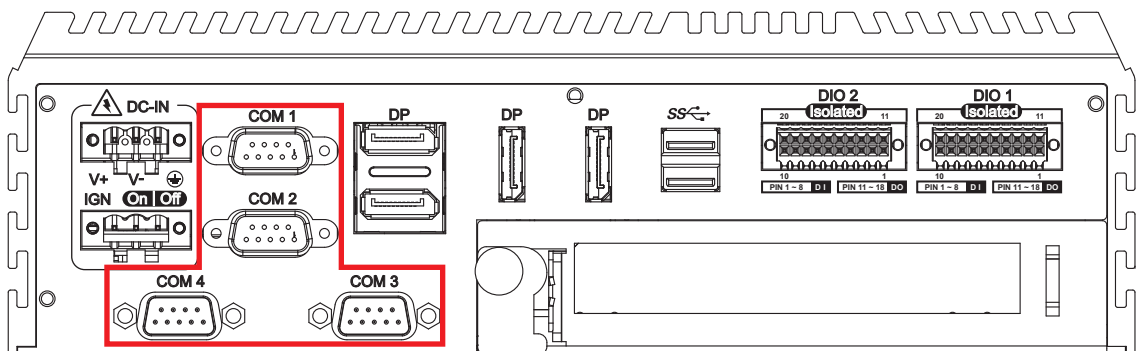

Serial port 1 to 4 (COM 1 to 4) can be configured for RS-232, RS-422, or RS-485 with auto flow control communication. The default definition of COM 1 and COM 2 is RS-232; but if you want to change to RS-422 or RS-485, you can find the setting in BIOS.

BIOS Setting	Function
COM 1 COM 2 COM 3 COM 4	RS-232
	RS-422 (5-wire)
	RS-422 (9-wire)
	RS-485
	RS-485 w/z auto-flow control

The pin assignments are listed in the following table :

Serial Port	Pin No.	RS-232	RS-422 (5-wire)	RS-422 (9-wire)	RS-485 (3-wire)
1 to 4	1	DCD	TXD-	TXD-	DATA-
	2	RXD	TXD+	TXD+	DATA+
	3	TXD	RXD+	RXD+	-
	4	DTR	RXD-	RXD-	-
	5	GND	GND	GND	GND
	6	DSR	-	RTS-	-
	7	RTS	-	RTS+	-
	8	CTS	-	CTS+	-
	9	RI	-	CTS-	-

COM 3 & COM 4 MB connector table :

COM Port	MB Connector	COM Port	MB Connector
COM 3	CN12	COM 4	CN13

COM 3 & COM 4 MB connector pin out :

CN	Pin No.	Signal Name	Pin No.	Signal Name
CN12 (COM 3) CN13 (COM 4)	1	Chassis GND	6	TXD
	2	GND	7	RTS
	3	RI	8	RXD
	4	DTR	9	DSR
	5	CTS	10	DCD

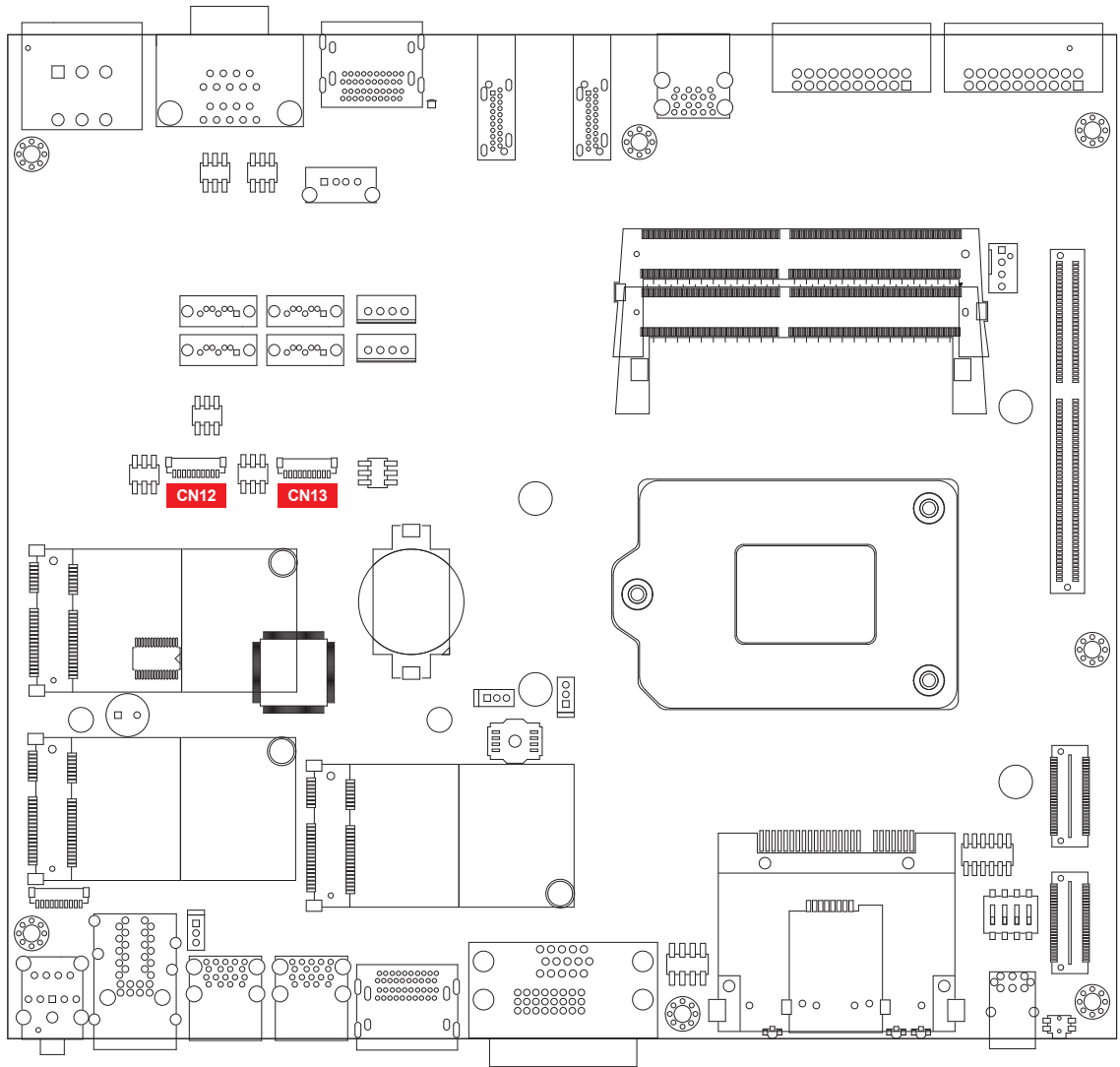

2.3.4 Rear USB 3.0

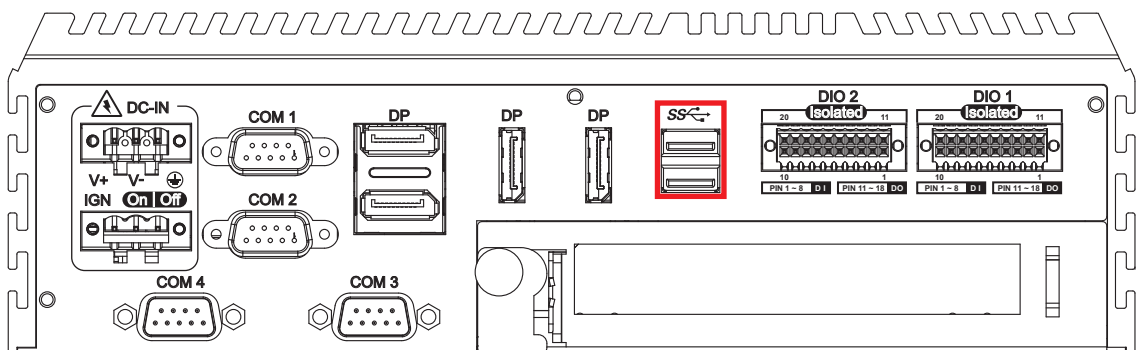

There are 2 USB 3.0 connections available supporting up to 5GB per second data rate in the rear side of EVS-1000/1100. It is also compliant with the requirements of Super Speed (SS), High Speed (HS), Full Speed (FS) and Low Speed (LS).

2.3.5 DisplayPort

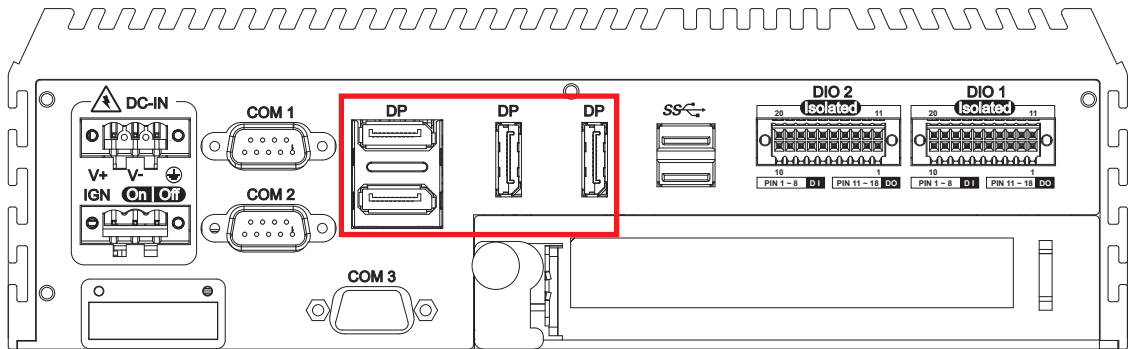
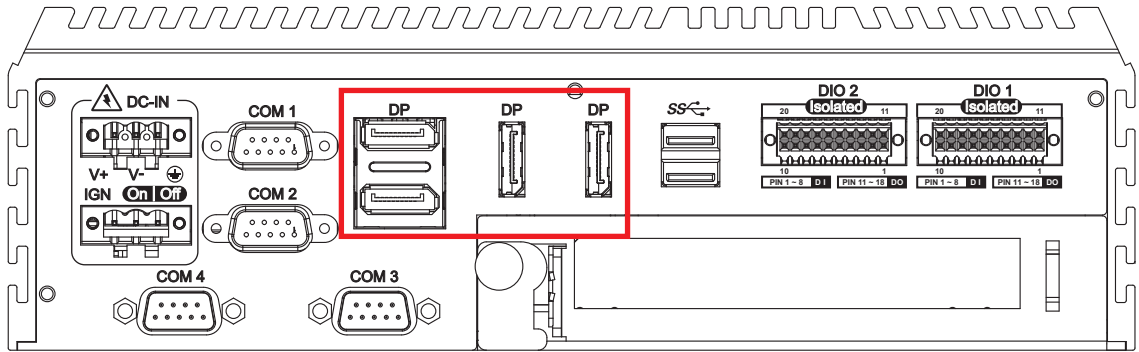

Multi-Stream Transport Display	Max. Resolution
Four panel displays concurrently	7680 x 4320 @60Hz

2.3.6 Isolated DIO

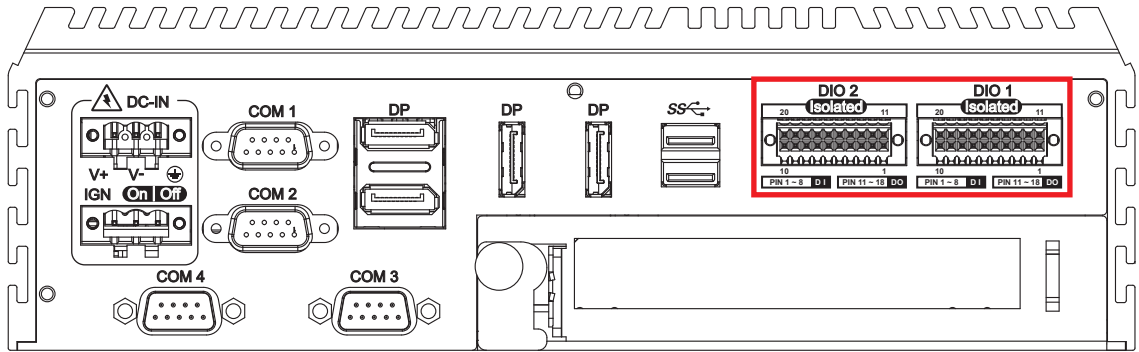

There is a 32-bit (16-bit DI, 16-bit DO) with 2 DIO connectors in the rear side. DI/DIO support NPN (Sink) and PNP (Source) mode, Each DI channel is equipped with a photocouper for isolated protection.

Each DO with isolator chip is configured by a software for each DIO connector.

DO Safety-Related Certifications :

- 4242-VPK Basic Isolation per DIN V VDE V 0884-10 and DIN EN 61010-1
- 3-KVRMS Isolation for 1 minute per UL 1577
- CSA Component Acceptance Notice 5A, IEC 60950-1 and IEC 61010-1 End Equipment Standards
- GB4943.1-2011 CQC Certified

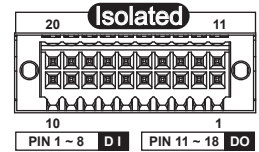

DIO	Pin No.	Definition	Function	Pin No.	Definition	Function
DIO1	1	EXT_IN8	DIO2_GPI0	11	EXT_OUT8	DIO2_GPO0
	2	EXT_IN9	DIO2_GPI1	12	EXT_OUT9	DIO2_GPO1
	3	EXT_IN10	DIO2_GPI2	13	EXT_OUT10	DIO2_GPO2
	4	EXT_IN11	DIO2_GPI3	14	EXT_OUT11	DIO2_GPO3
	5	EXT_IN12	DIO2_GPI4	15	EXT_OUT12	DIO2_GPO4
	6	EXT_IN13	DIO2_GPI5	16	EXT_OUT13	DIO2_GPO5
	7	EXT_IN14	DIO2_GPI6	17	EXT_OUT14	DIO2_GPO6
	8	EXT_IN15	DIO2_GPI7	18	EXT_OUT15	DIO2_GPO7
	9	+VDI_COM1	-	19	GND_ISO_DIO1	-
	10	GND_ISO_DIO1	-	20	+VDIO_EXT1 (6~48V Input)	-

DIO	Pin No.	Definition	Function	Pin No.	Definition	Function
DIO2	1	EXT_IN0	SIO_GPI80	11	EXT_OUT0	SIO_GPO70
	2	EXT_IN1	SIO_GPI81	12	EXT_OUT1	SIO_GPO71
	3	EXT_IN2	SIO_GPI82	13	EXT_OUT2	SIO_GPO72
	4	EXT_IN3	SIO_GPI83	14	EXT_OUT3	SIO_GPO73
	5	EXT_IN4	SIO_GPI84	15	EXT_OUT4	SIO_GPO74
	6	EXT_IN5	SIO_GPI85	16	EXT_OUT5	SIO_GPO75
	7	EXT_IN6	SIO_GPI86	17	EXT_OUT6	SIO_GPO76
	8	EXT_IN7	SIO_GPI87	18	EXT_OUT7	SIO_GPO77
	9	+VDI_COM	-	19	GND_ISO_DIO	-
	10	GND_ISO_DIO	-	20	+VDIO_EXT (6~48V Input)	-

DI Reference Circuit :

Sink Mode (NPN)

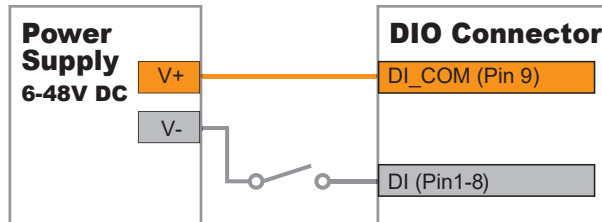

Source Mode (PNP)

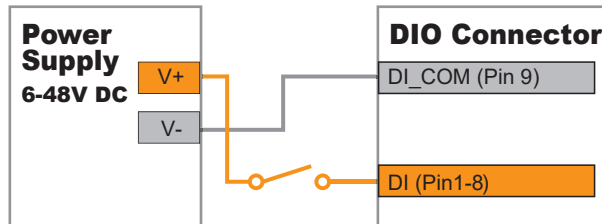

DO Reference Circuit :

Sink Mode (NPN, Default)

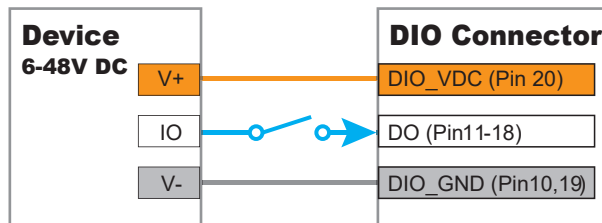

Source Mode (PNP)

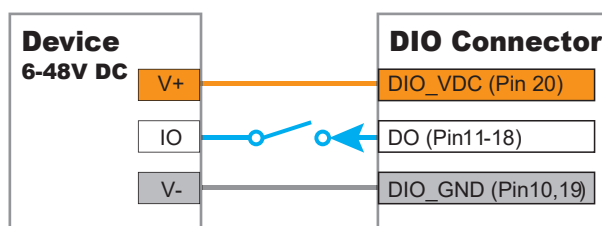

2.3.7 Add Card

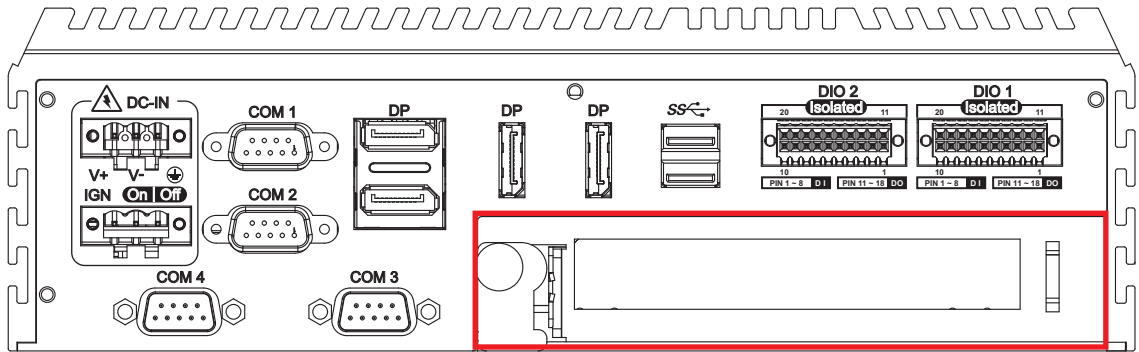

Optional for PCIe x16 FHHL add on card or PCI card.

2.4 Main Board Expansion Connectors

2.4.1 EVS-1000/1100 Main Board with Connector Location

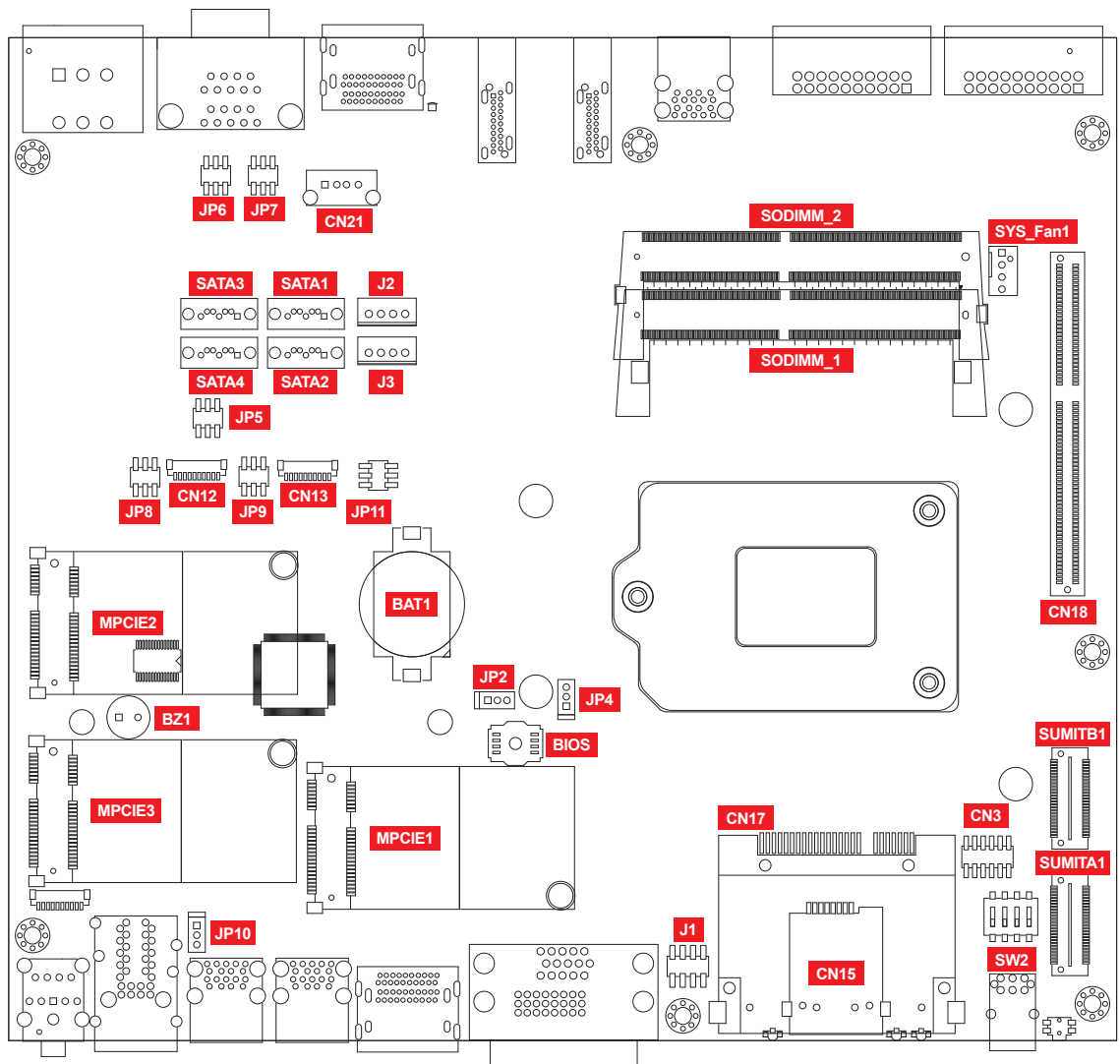

2.4.2 Miscellaneous Pin Header

2.0mm 2x4p Header

This pin header can be used as a backup for following functions, such as hard drive LED indicator, reset button, power LED indicator, and power-on/off button, which already can be accessed by front panel and top panel. The pin-outs of Miscellaneous port are listed in following table :

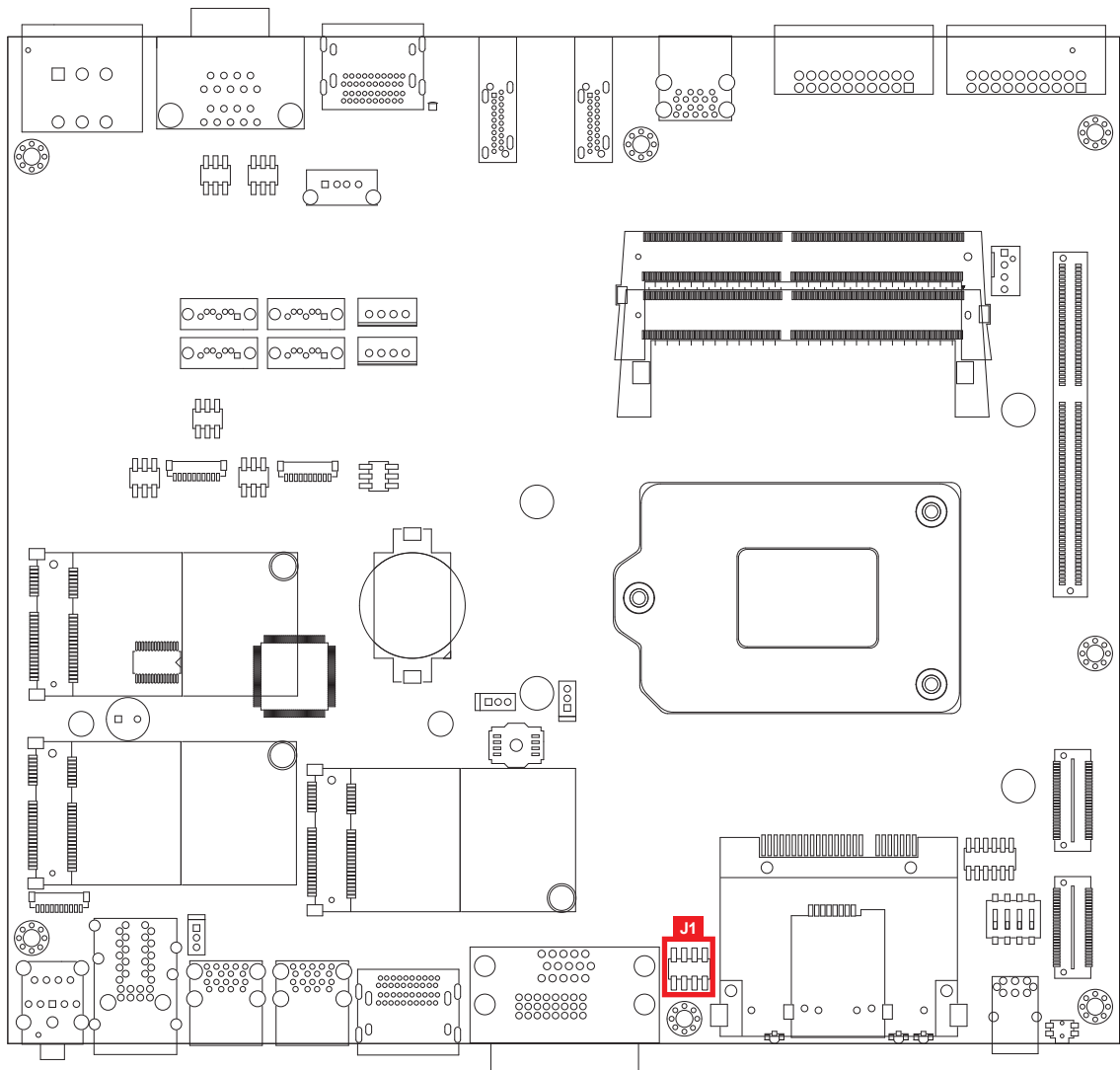

Group	Pin No.	Definition
HDD LED	1	HDD_LED_P
	3	HDD_LED_N
RESET BUTTON	5	FP_RST_BTN_N
	7	Ground
POWER LED	2	PWR_LED_P
	4	PWR_LED_N
POWER BUTTON	6	FP_PWR_BTN_P
	8	Ground

2.4.3 DDR4 Slot

There are 2 DDR4 channel onboard supporting DDR4 2400/2133 and up to 64GB. (Each channel 16GB)

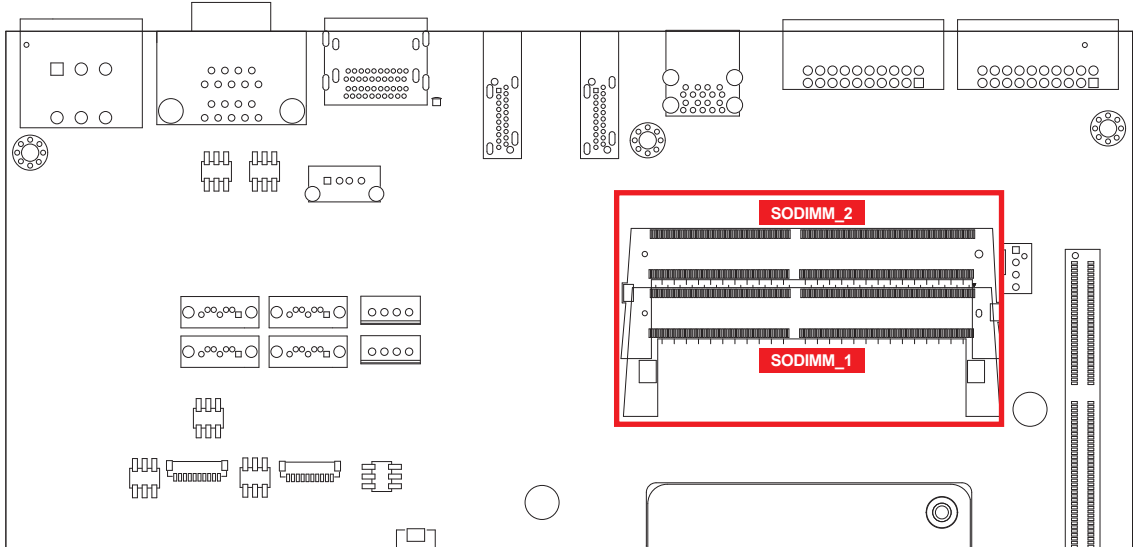

Slot	Description
SODIMM_1	DDR4 Channel A
SODIMM_2	DDR4 Channel B

2.4.4 BIOS Socket

If the BIOS need to be changed, please contact the Vecow RMA service team.

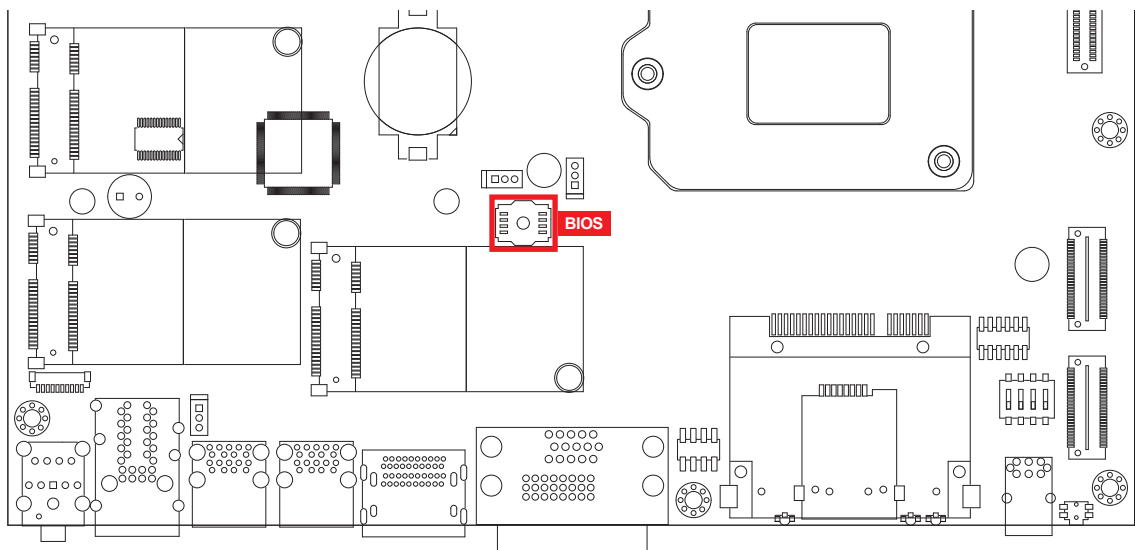

2.4.5 SATA Connector

Standard 7 PIN SATA Connector

There are 4 onboard high performance Serial ATA III. It supports higher storage capacity with less cabling effort and smaller required space.

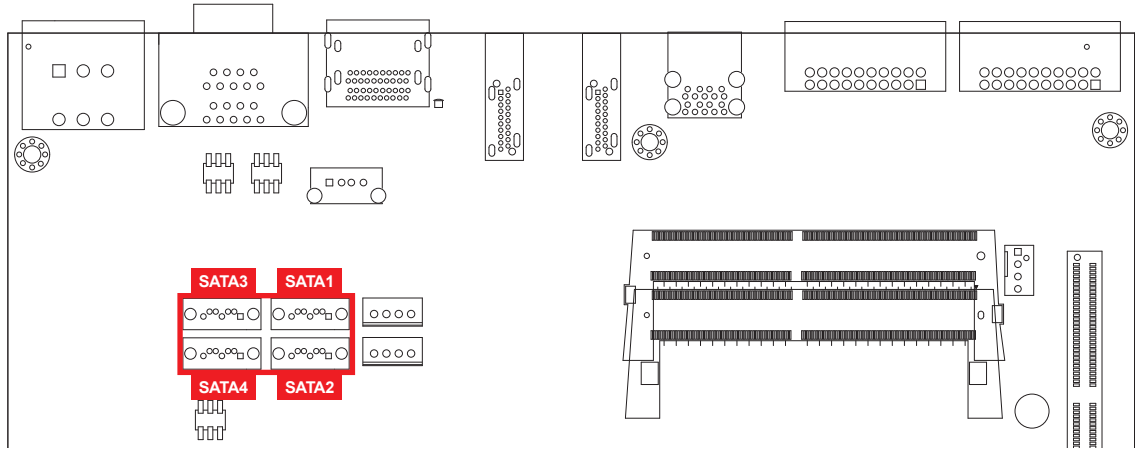

Pin No.	Description	Pin No.	Description
1	Ground	5	RX DN
2	TX DP	6	RX DP
3	TX DN	7	Ground
4	Ground		

2.4.6 SATA Power Header

Standard, All Form Factor 1x4p Power Header

There are 2 HDD power headers on board and each power header supports 2 2.5" SATA HDDs.

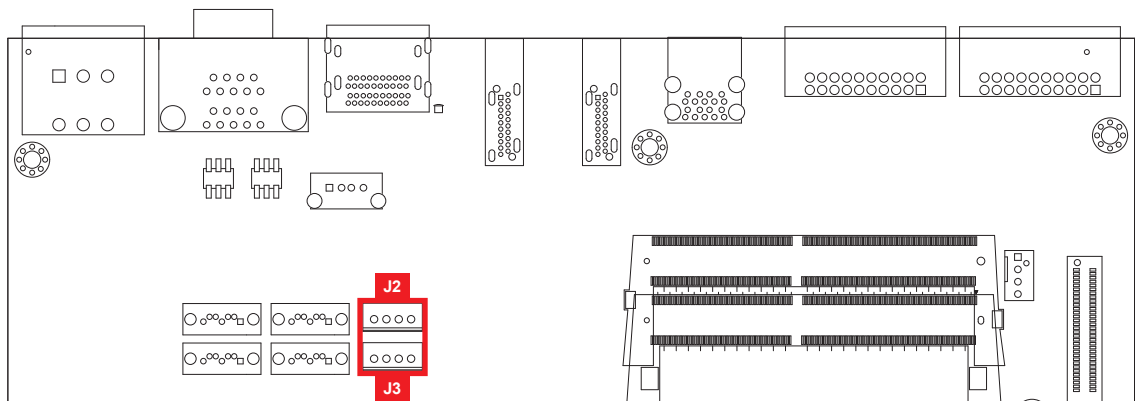

Pin No.	Description	Pin No.	Description
1	+V12 (Max. 1.5A)	2	Ground
3	Ground	4	+V5 (Max. 4A)

2.4.7 Internal USB 2.0

Standard Vertical USB 2.0 Connector

The EVS-1000/1100 main board provides one expansion USB port using plug-and-play for Dongle Key or LCD Touch Panel. The USB interface supports 480 Mbps transfer rate complied with high speed USB specification Rev. 2.0.

The USB interface is accessed through one standard USB 2.0 connector. This USB 2.0 does not support wake up function.

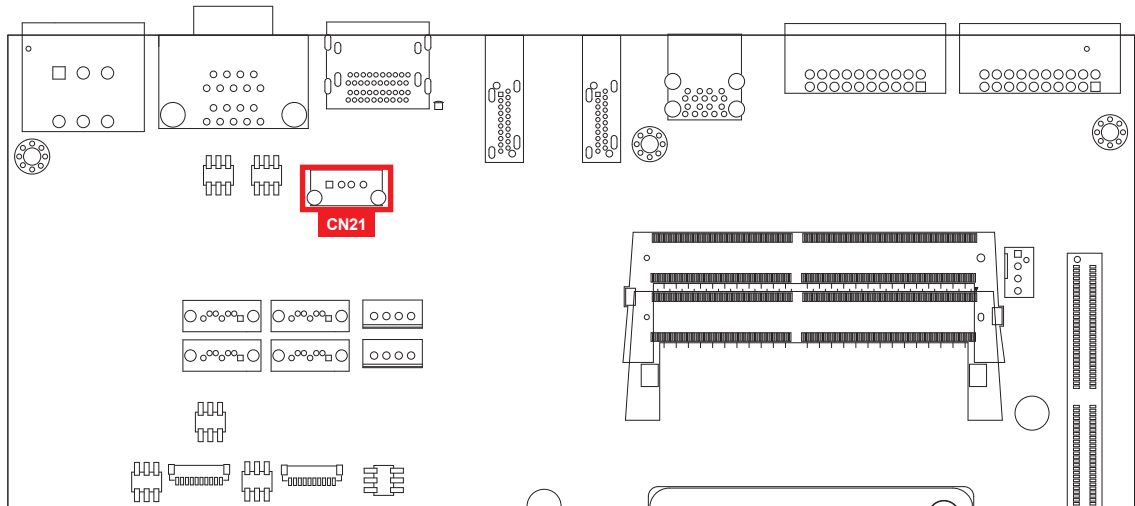

Pin No.	Description	Pin No.	Description
1	USB +VCC (+V5/Max. 0.5A)	2	DATA-
3	DATA+	4	Ground

2.4.8 SUMIT A, SUMIT B

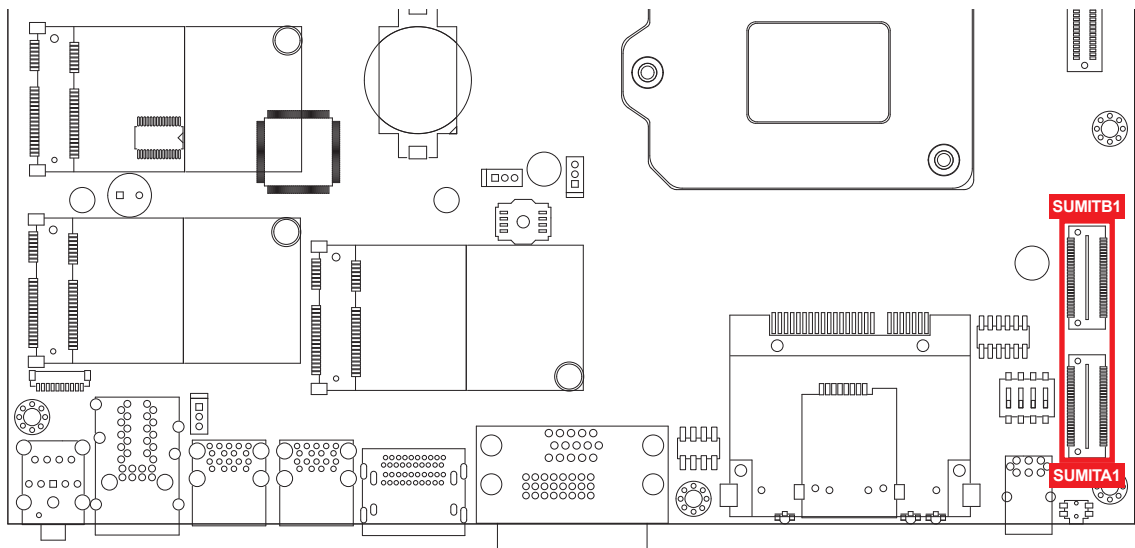

SUMIT A Pin Out :

Pin No.	Function	Pin No.	Function
1	+5V_AUX	2	+12V
3	+3.3V	4	SMB_DATA
5	+3.3V	6	XMB_CLK
7	Reserved	8	Reserved
9	Reserved	10	SPI_MISO
11	USB_OC#	12	SPI_MOSI
13	Reserved	14	SPI_CLK
15	+5V	16	SPI_CS10
17	USB_3+	18	SPI_CS1#
19	USB_3-	20	Reserved
21	+5V	22	LPC_DRQ1#
23	USB_2+	24	LPC_AD0
25	USB_2-	26	LPC_AD1
27	+5V	28	LPC_AD2
29	USB_1+	30	LPC_AD3
31	USB_1-	32	LPC_FRAME#
33	+5V	34	SERIRQ#
35	USB_0+	36	Reserved
37	USB_0-	38	CLK_33MHz
39	GND	40	GND
41	A_PET_P0	42	A_PER_P0
43	A_PET_N0	44	A_PER_N0
45	GND	46	APRSNT#/A_PE_CLKREQ#
47	PERST#	48	A_CLKP
49	WAKE#	50	A_CLKN
51	+5V	52	GND

SUMIT B Pin Out :

Pin No.	Function	Pin No.	Function
1	GND	2	GND
3	B_PET_P0	4	B_PER_P0
5	B_PET_N0	6	B_PER_N0
7	GND	8	GND
9	C_CLKP	10	B_CLKP
11	C_CLKN	12	B_CLKN
13	CPRSNT#/C_PE_CLKREQ#	14	GND
15	C_PET_P0	16	C_PER_P0
17	C_PET_N0	18	C_PER_N0
19	GND	20	GND
21	C_PET_P1	22	C_PER_P1
23	C_PET_N1	24	C_PER_N1
25	GND	26	GND
27	C_PET_P2	28	C_PER_P2
29	C_PET_N2	30	C_PER_N2
31	GND	32	GND
33	C_PET_P3	34	C_PER_P3
35	C_PET_N3	36	C_PER_N3
37	GND	38	GND
39	PERST#	40	WAKE#
41	Reserved	42	Reserved
43	+5V	44	Reserved
45	+5V	46	+3.3V
47	+5V	48	+3.3V
49	+5V	50	+3.3V
51	+5V	52	+5V_AUX

2.4.9 Mini PCIe

Standard Full Length Mini PCIe Slot :

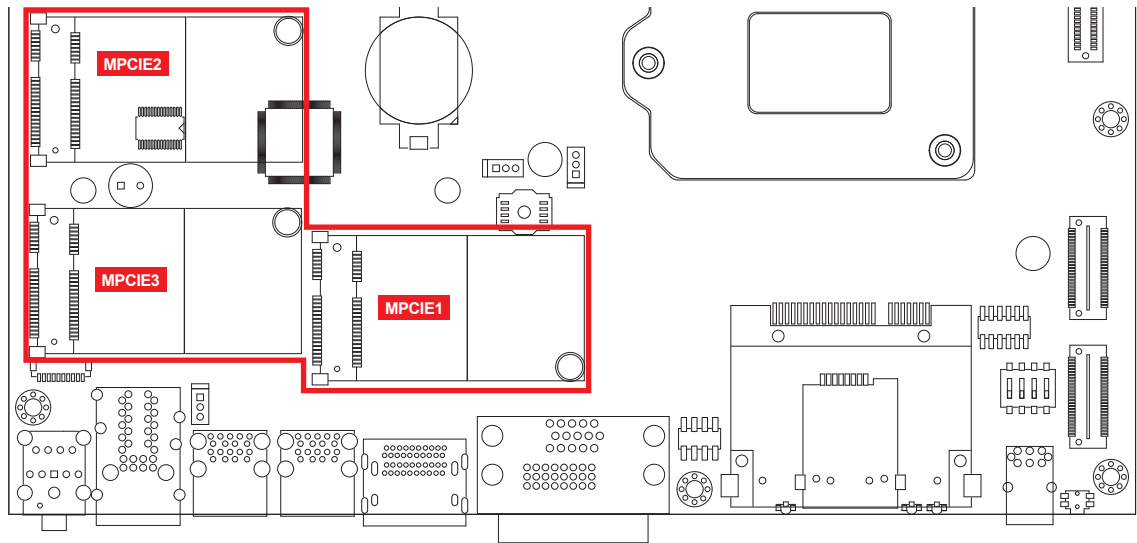

Pin Out :

Pin No.	Description	Pin No.	Description
51	Reserved	52	+3.3Vaux
49	Reserved	50	GND
47	Reserved	48	+1.5V
45	Reserved	46	Reserved
43	GND	44	Reserved
41	+3.3Vaux	42	Reserved
39	+3.3Vaux	40	GND
37	GND	38	USB_D+
35	GND	36	USB_D-
33	PETp0	34	GND
31	PETn0	32	SMB_DATA
29	GND	30	SMB_CLK
27	GND	28	+1.5V
25	PERn0	26	GND
23	PERp0	24	+3.3Vaux
21	GND	22	PERST#
19	Reserved	20	reserved
17	Reserved	18	GND

Mechanical Key			
15	GND	16	UIM_VPP
13	REFCLK+	14	UIM_RESET
11	REFCLK-	12	UIM_CLK
9	GND	10	UIM_DATA
7	CLKREQ#	8	UIM_PWR
5	Reserved	6	1.5V
3	Reserved	4	GND
1	WAKE#	2	3.3Vaux

2.4.10 RTC Battery

The system's real-time clock is powered by a lithium battery. It is Equipped with Panasonic BR2032 190mAh lithium battery. It is recommended that you not replace the lithium battery on your own. If the battery needs to be changed, please contact the Vecow RMA service team.

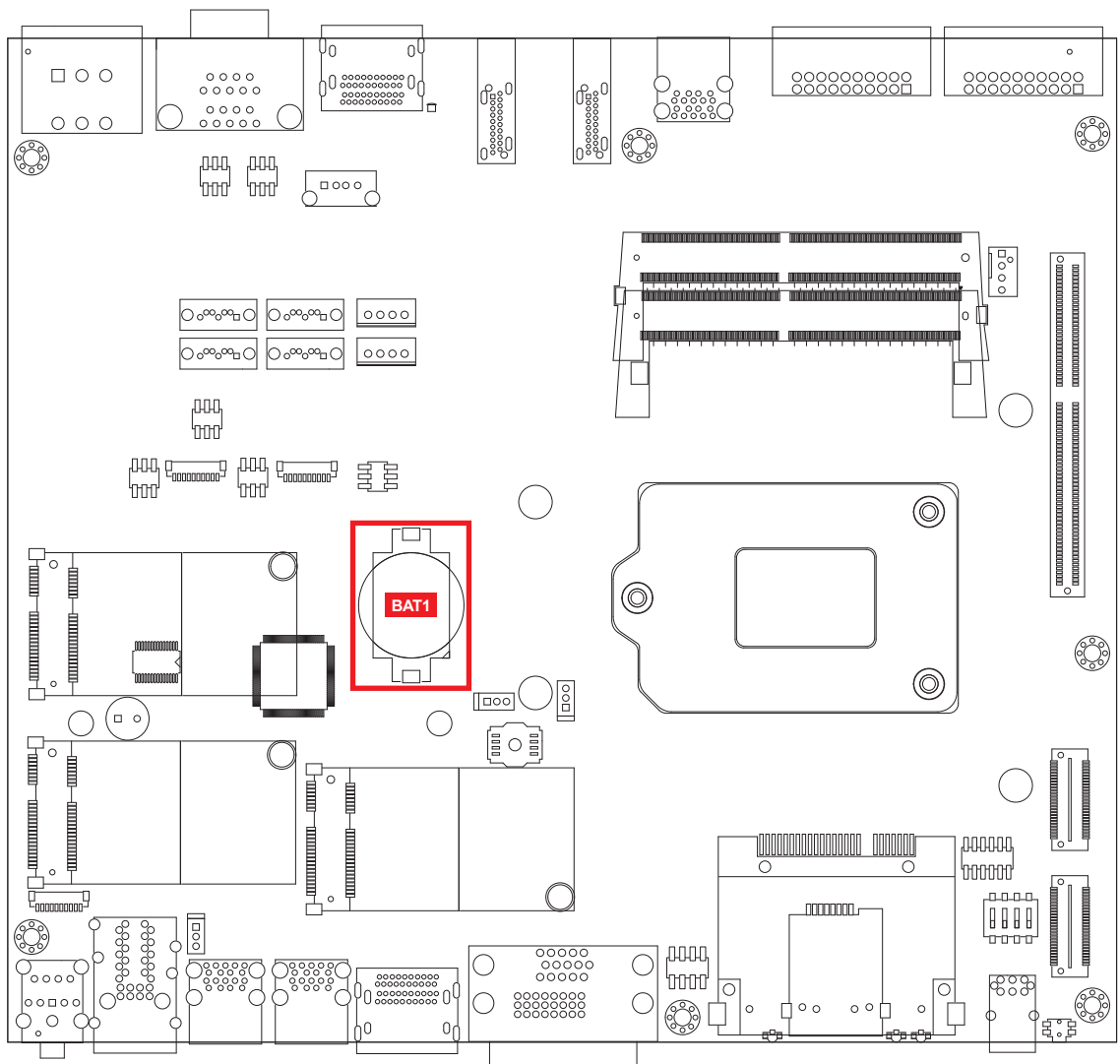

2.4.11 FAN Header

Fan power connector supports for additional thermal requirements. The pin assignments of SYS_FAN1 are listed in the following table.

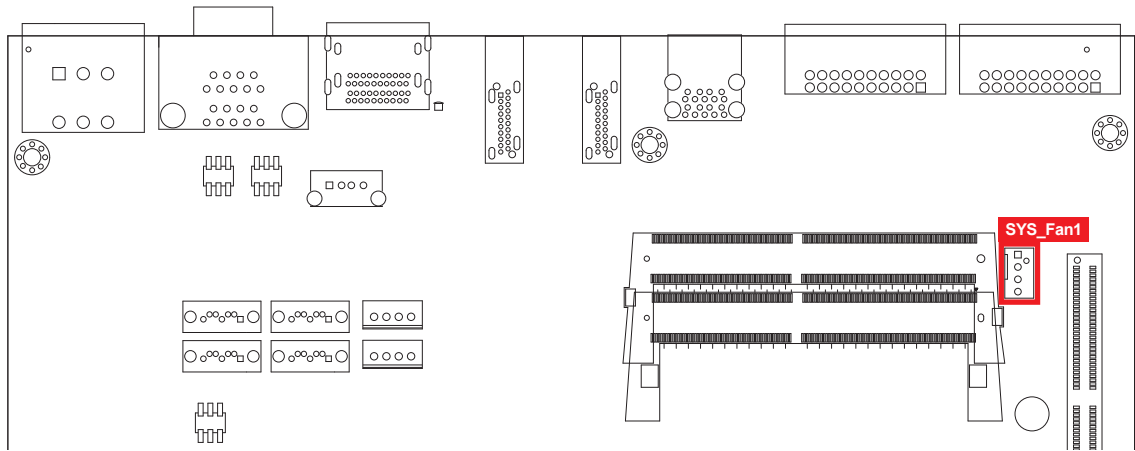

Pin No.	Description	Pin No.	Description
1	GND	2	+12V (1.5A max)
3	Fan speed sensor	4	Fan PWM

2.4.12 LPC Port 80 Header

The EVS-1000/1100 provide a LPC Port 80 Header for Debug Card.

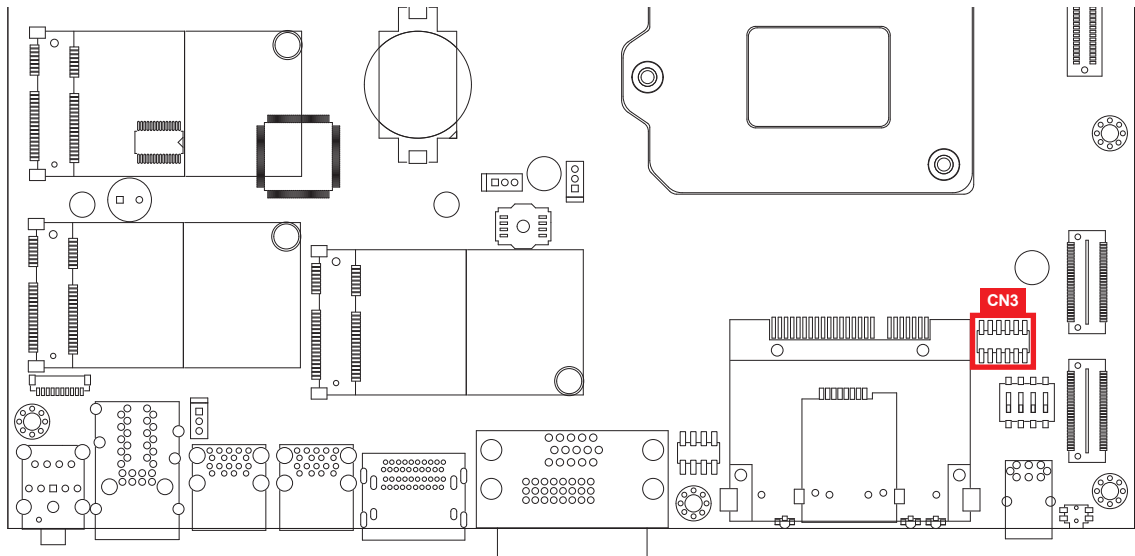

Pin No.	Description	Pin No.	Description
1	SERIRQ	7	LFRAME#
2	+3.3V	8	LAD0
3	LA3	9	N/C
4	RESET#	10	Ground
5	LAD1	11	CLOCK
6	LAD2	12	Ground

2.4.13 COM Port Header

EVS-1000/1100 provides 2 COM port headers for internal COM port cable.

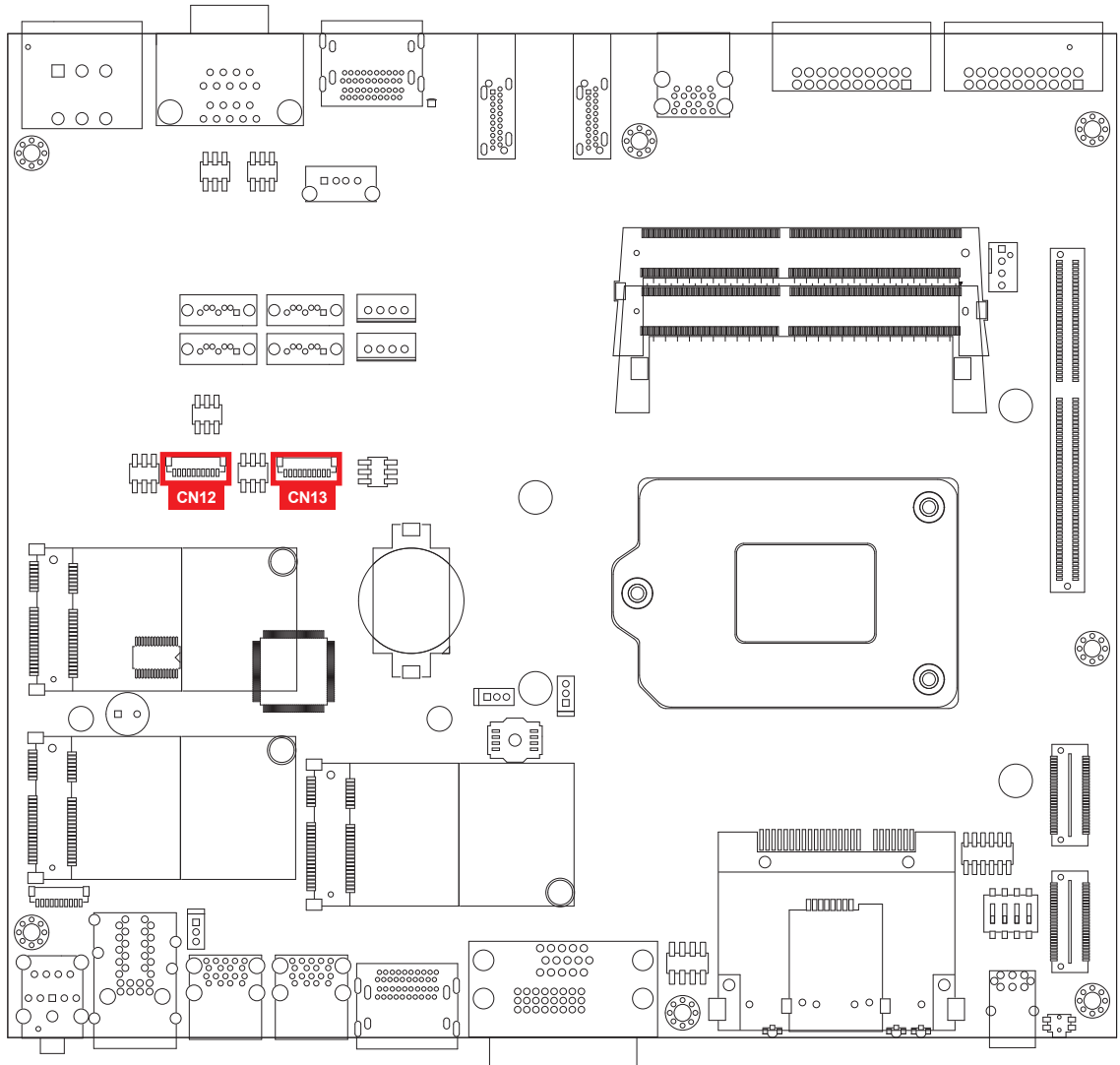

Pin Out :
CN12

Pin No.	Description	Pin No.
1	Ground_Frame	COM 3
2	Ground	COM 3
3	RI	COM 3
4	DTR	COM 3
5	CTS	COM 3
6	TXD	COM 3
7	RTS	COM 3
8	RXD	COM 3
9	DSR	COM 3
10	DCD	COM 3

CN13

Pin No.	Description	Pin No.
1	Ground_Frame	COM 4
2	Ground	COM 4
3	RI	COM 4
4	DTR	COM 4
5	CTS	COM 4
6	TXD	COM 4
7	RTS	COM 4
8	RXD	COM 4
9	DSR	COM 4
10	DCD	COM 4

2.5 Main Board Jumper and DIP Switch Settings

2.5.1 Board Top View of EVS-1000/1100 Main Board With Jumper and DIP Switch

The figure below is the top view of EVS-1000/1100 main board which is the main board. It shows the location of the jumpers and the switches.

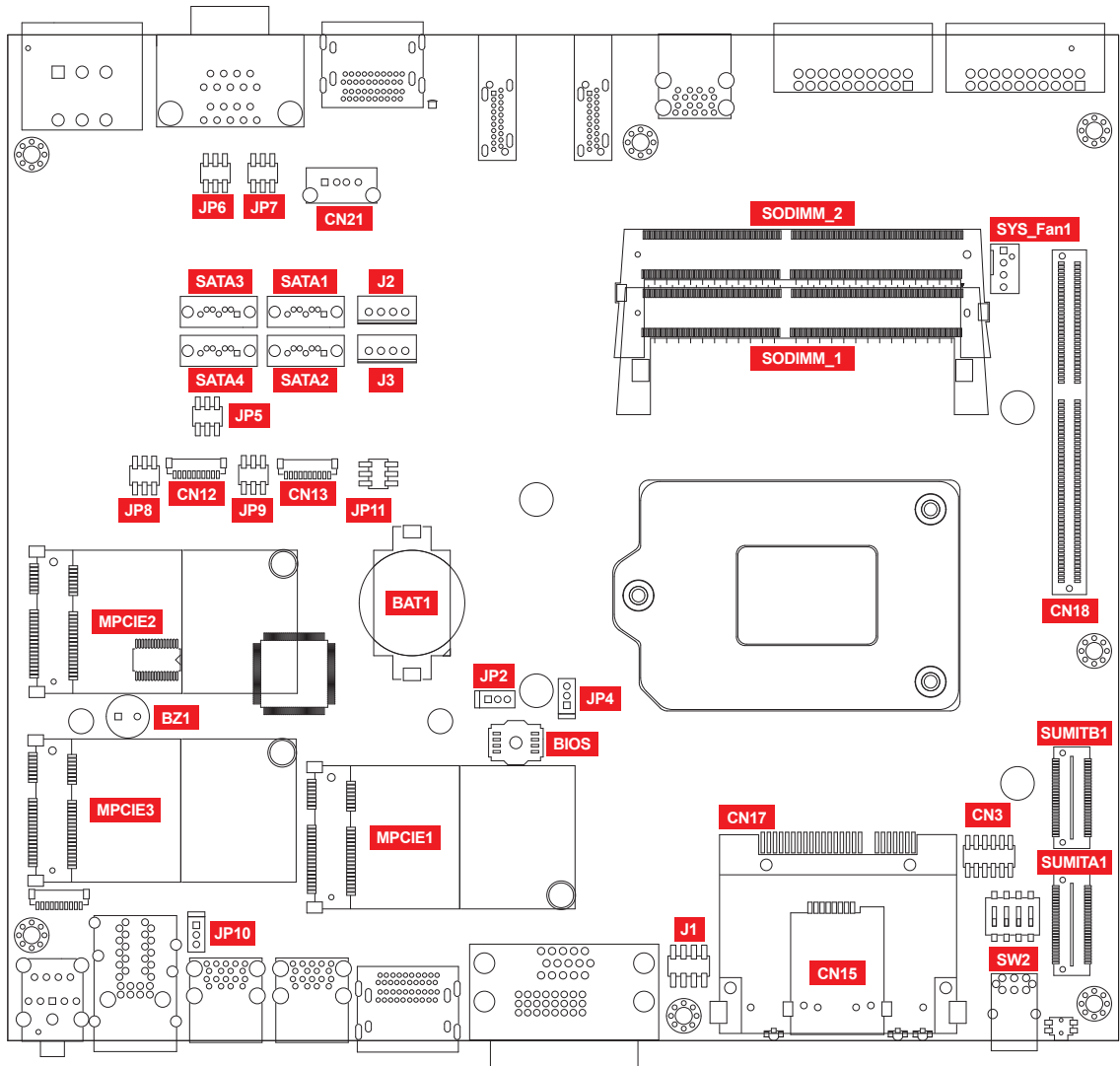

You may configure your card to match the needs of your application by setting jumpers. A jumper is a metal bridge used to close an electric circuit. It consists of two metal pins and a small metal clip (often protected by a plastic cover) that slides over the pins to connect them. To "close" a jumper, you connect the pins with the clip. To "open" a jumper, you remove the clip. Sometimes a jumper will have three pins, labeled 1, 2 and 3. In this case you would connect either pins 1 and 2, or 2 and 3.

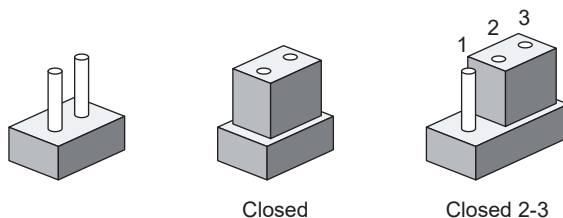

You may configure your card to match the needs of your application by DIP switch. As below show the DIP switch on and off.

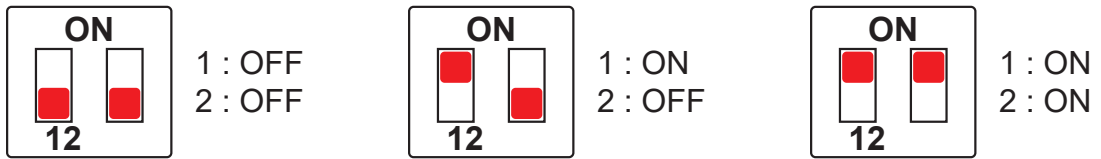

2.5.2 USB Power Jumper

The figure below is the top view of EVS-1000/1100 main board which is the main board. It shows the location of the jumpers and the switches.

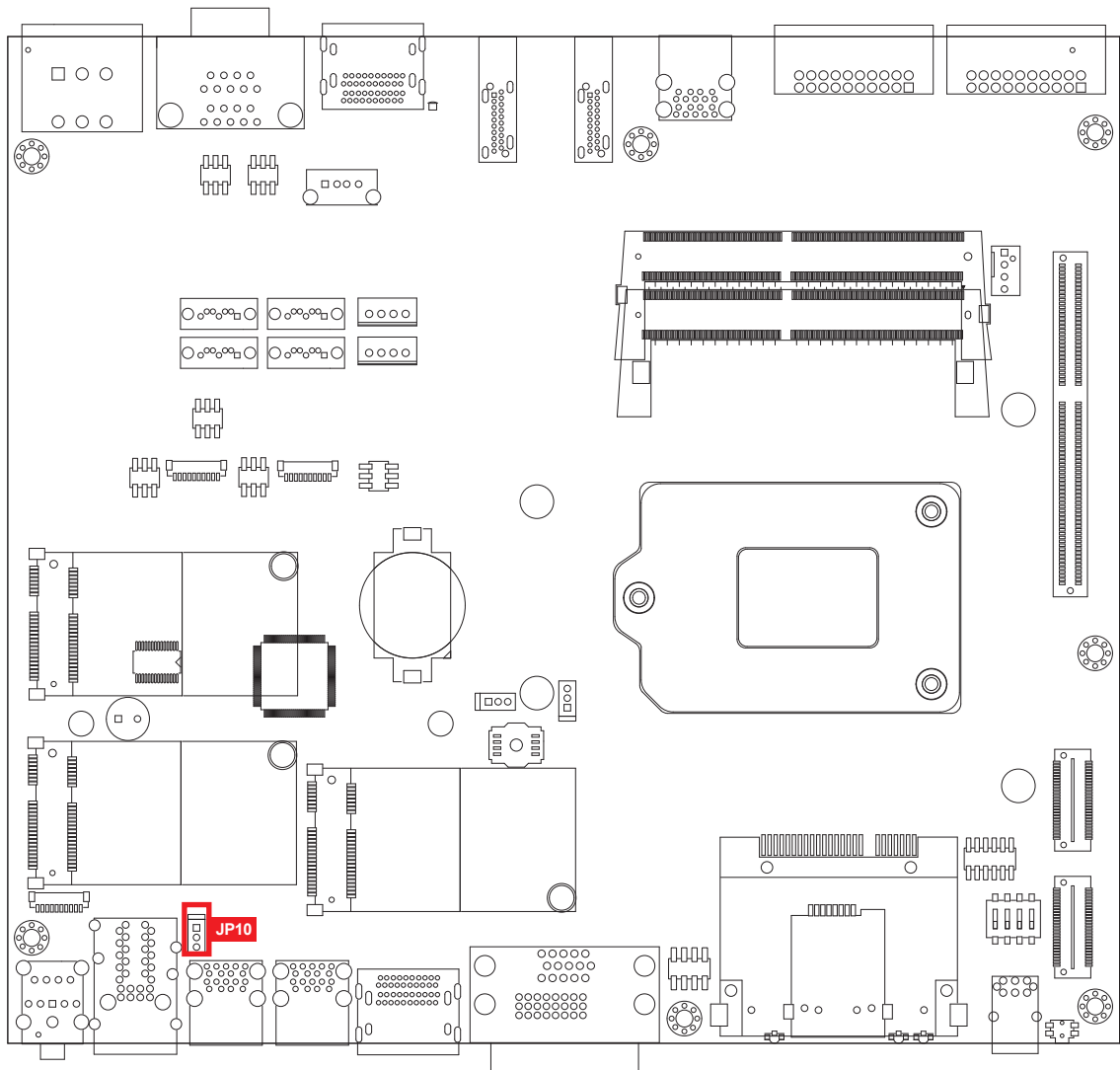

Jumper	Setting	Function
JP10	1 : 2	Supported Wake Up (Default)
JP10	2 : 3	Non Wake Up support

2.5.3 COM Port RI Pin Select

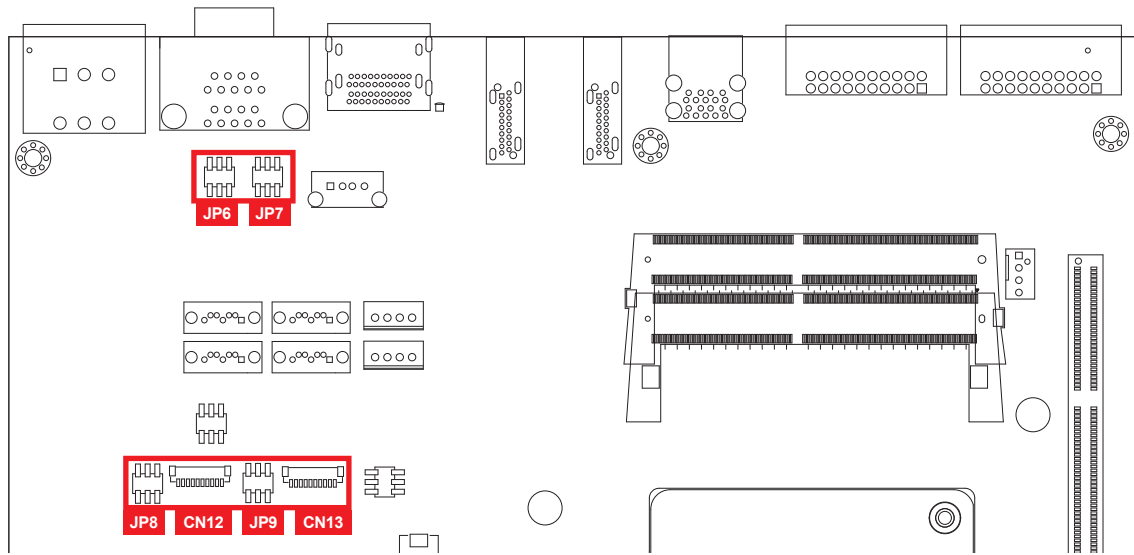

Pin Header	Pin No.	Description
COM 1 JP6	1 - 2	+5V (1A max.)
	3 - 4	+12V (0.5A max.)
	5 - 6	RI (Default)

Pin Header	Pin No.	Description
COM 2 JP7	1 - 2	+5V (1A max.)
	3 - 4	+12V (0.5A max.)
	5 - 6	RI (Default)

Pin Header	Pin No.	Description
COM 3 JP8	1 - 2	+5V (1A max.)
	3 - 4	+12V (0.5A max.)
	5 - 6	RI (Default)

Pin Header	Pin No.	Description
COM 4 JP9	1 - 2	+5V (1A max.)
	3 - 4	+12V (0.5A max.)
	5 - 6	RI (Default)

2.5.4 MXM VGA Disable

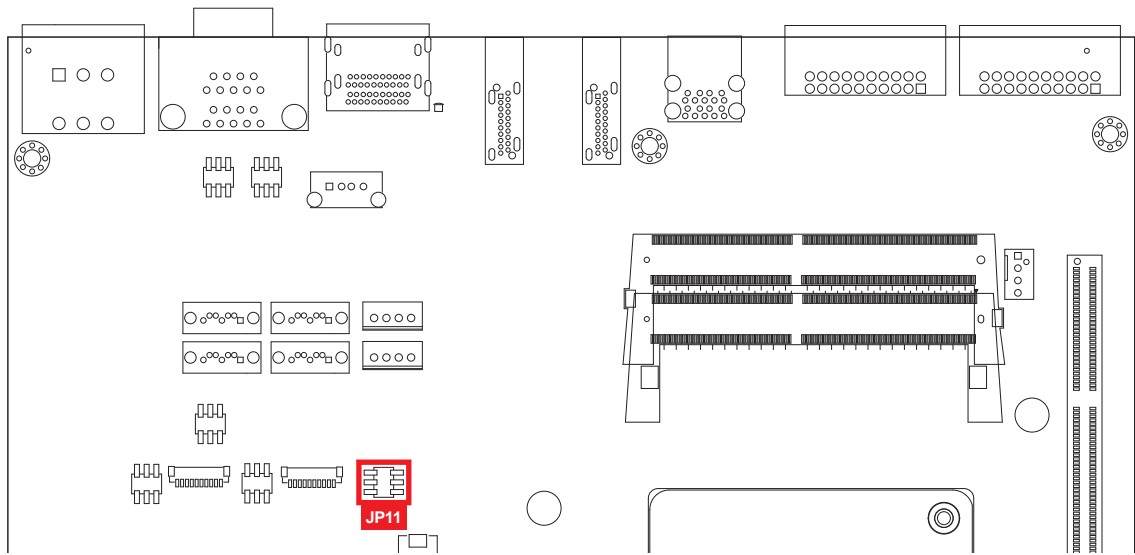

Jumper	Setting	Function
JP11	1 : 3	MXM VGA Enable
JP11	3 : 5	MXM VGA Disable

2.5.5 Clear CMOS

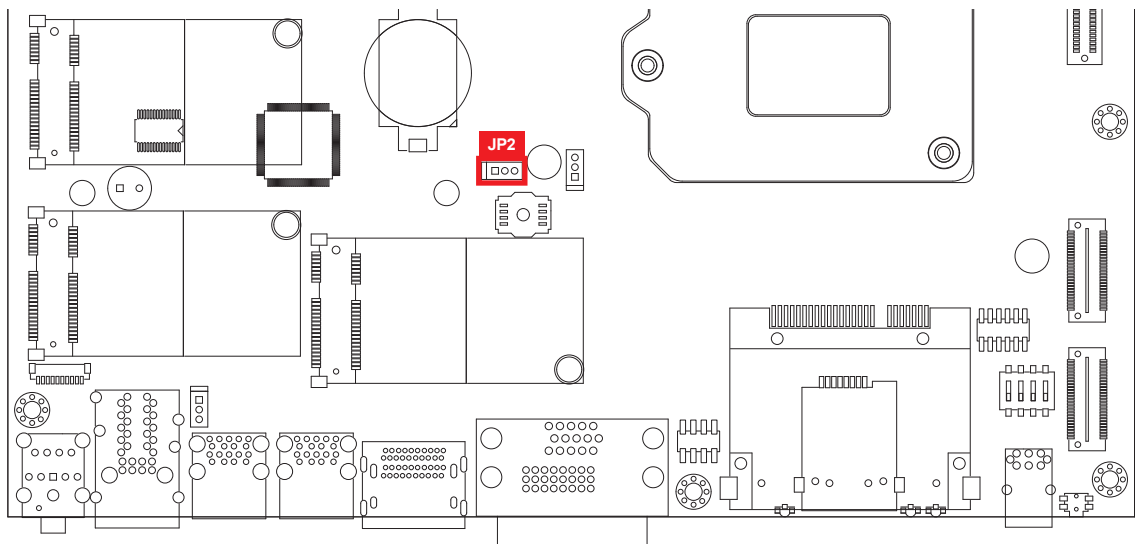

Jumper	Setting	Function
JP2	1 : 2	*Normal (Default)
JP2	2 : 3	Clear CMOS

2.5.6 HDA_SDO

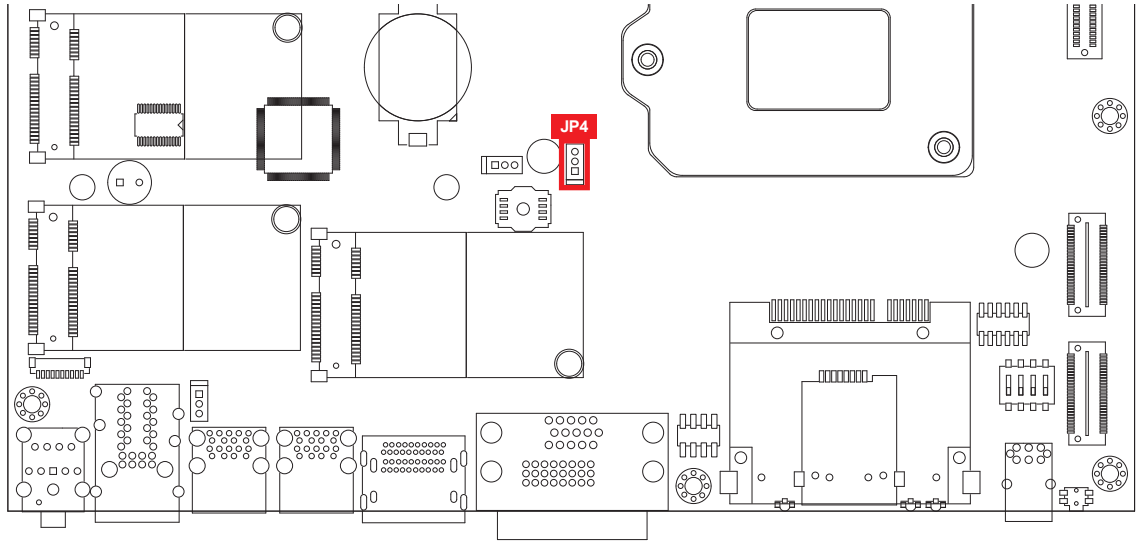

Jumper	Setting	Function
JP4	1 : 2	*Enable security measures defined in the Flash Descriptor (Default)
JP4	2 : 3	Disable Flash Descriptor Security (Override)





2.6 Ignition Control

EVS-1000/1100 series provides ignition power control feature for in-vehicle applications. The built-in MCU monitors the ignition signal and turns on/off the system according to pre-defined on/off delay period.

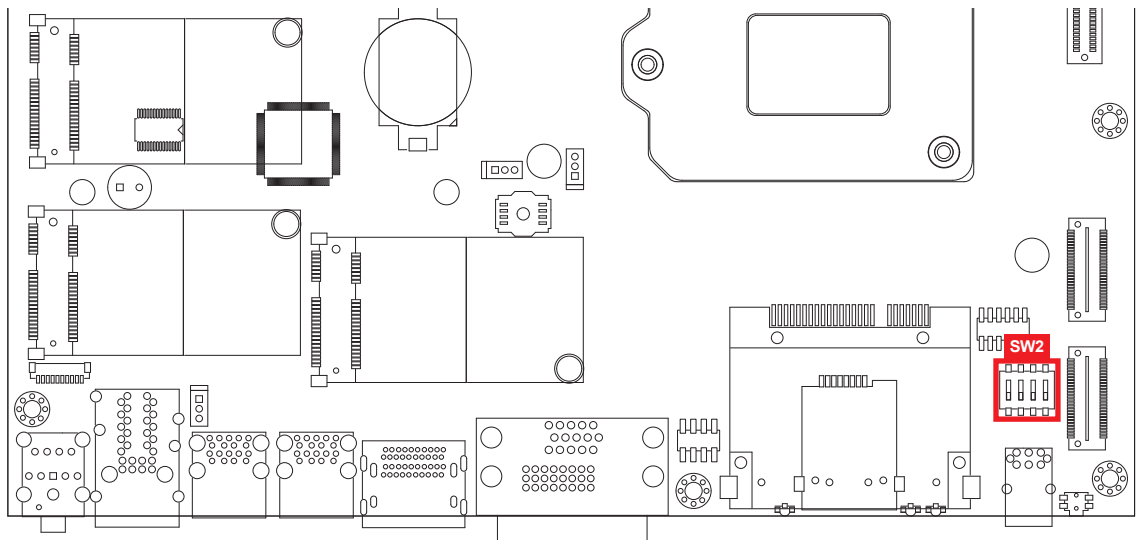
2.6.1 Adjust Ignition Control Modes

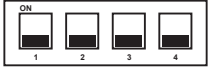
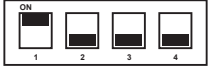
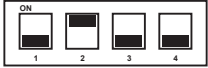
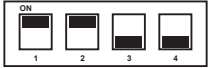
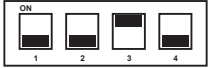
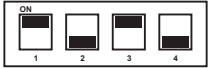
EVS-1000/1100 series provides 16 modes of different power on/off delay periods adjustable via SW2 switch. The default switch is set to 0 in ATX/AT power mode.

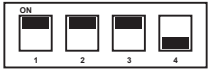
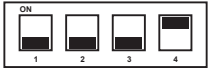
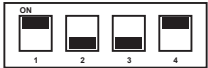
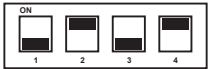
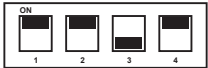

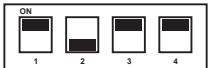
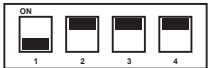
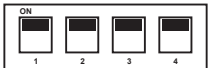
Item	Power On Delay	Power Off Delay	Switch Position
0	ATX/AT mode (Default)		
1	No delay	No delay	
2	No delay	5 seconds	
3	No delay	10 seconds	
4	No delay	20 seconds	
5	5 seconds	30 seconds	
6	5 seconds	60 seconds	
7	5 seconds	90 seconds	
8	5 seconds	30 minutes	
9	5 seconds	1 hour	
A	10 seconds	2 hours	
B	10 seconds	4 hours	
C	10 seconds	6 hours	
D	10 seconds	8 hours	
E	10 seconds	12 hours	
F	10 seconds	24 hours	

2.6.2 Ignition Control Wiring

To activate ignition control, you need to provide IGN signal via the 3-pin pluggable terminal block located in the back panel. It is below the general wiring configuration.



Pin No.	Definition
1	Ignition (IGN)
2	External Power S/W +
3	External Power S/W +

For testing purpose, you can refer to the picture blow to simulate ignition signal input controlled by a latching switch.

Note :

1. DC power source and IGN share the same ground.
2. EVS-1000/1100 supports 10V to 36V wide range DC power input in ATX/AT mode. In Ignition mode, the input voltage is fixed to 12V/24V for car battery scenario.
3. For proper ignition control, the power button setting should be "Power Down" mode.

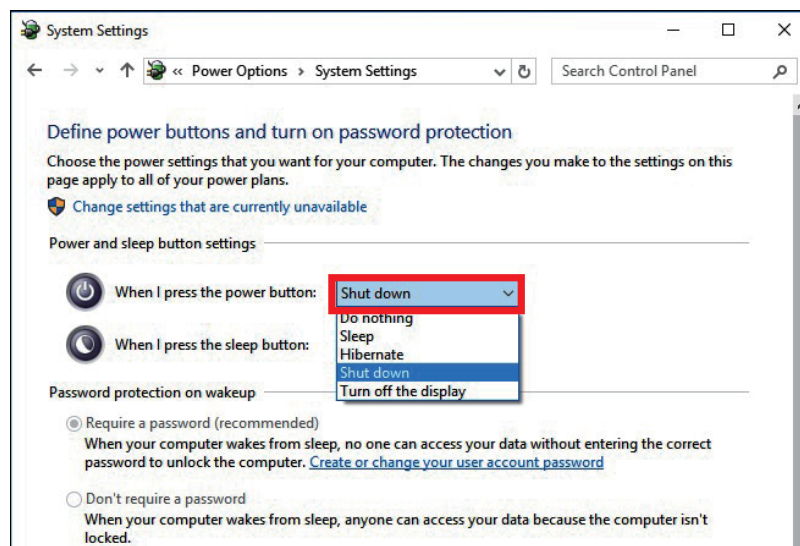

In Windows, for example, you need to set "When I press the power button" to "Shut down."

3

SYSTEM SETUP

3.1 How to Open Your EVS-1000/1100

Step 1 Remove hole plugs.



Step 2 Remove two F#6-32 screws (circled in red), two F-M3 screws (circled in yellow) on the bottom side and one cover (circled in green)

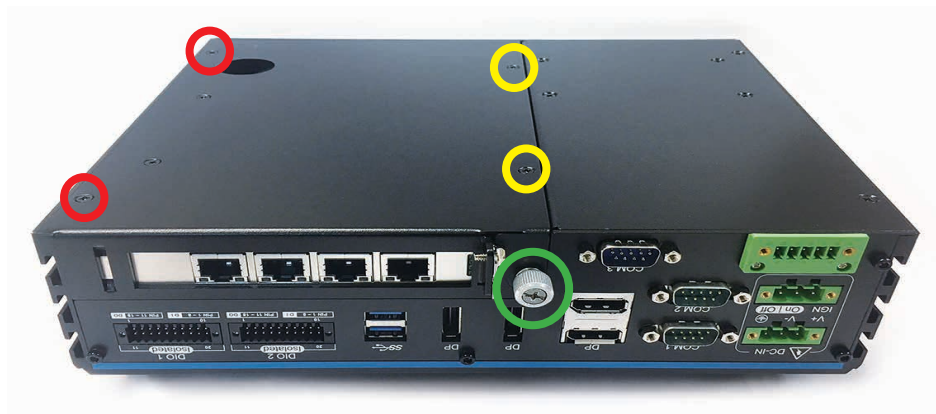



Step 3 Take off the PCI/PCIe tray.



Step 4 Remove one KHS#6-32 screws and two SSD/HDD trays on the front panel.

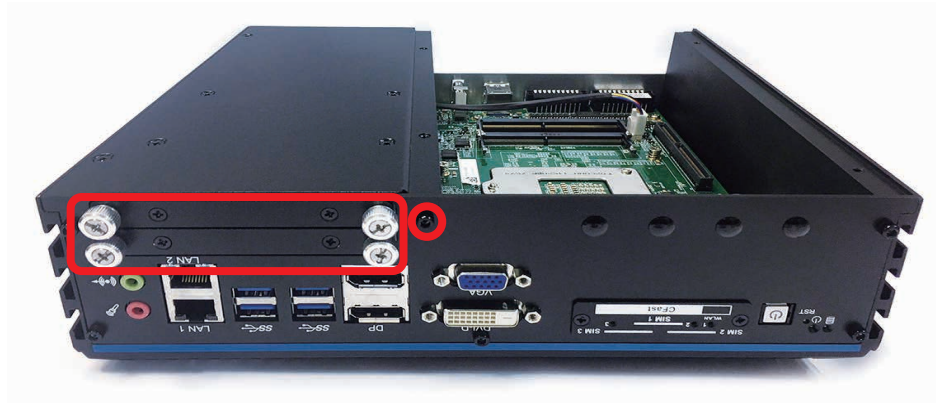

Step 5 Remove two F-#6-32 screws at the bottom side.



Step 6 Take off SSD/HDD module. (Be careful pull to out SATA Power Cable)

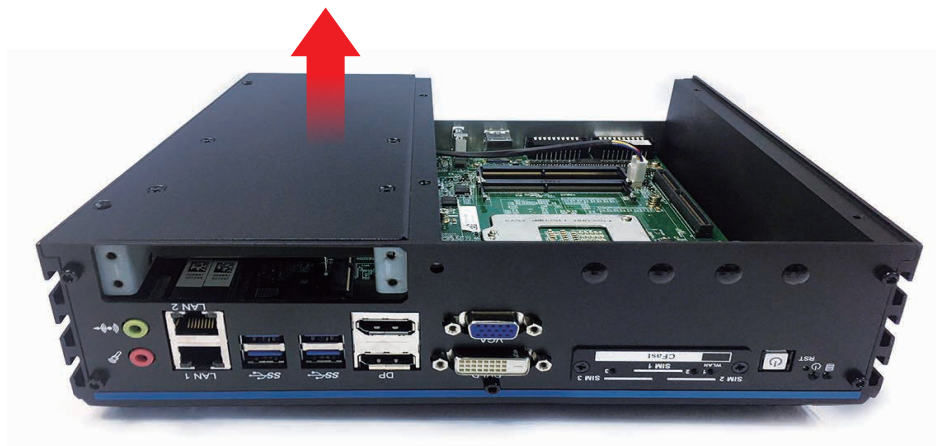

Step 7 Remove five KHS-#6-32 screws.

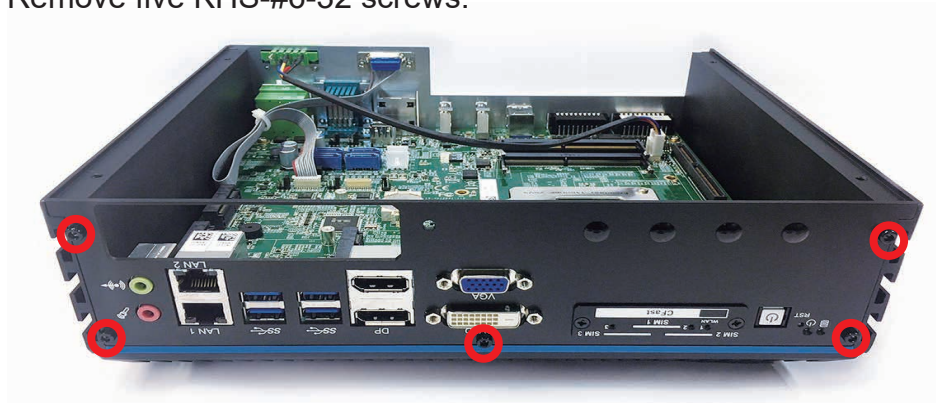

Step 8 Remove the front panel.

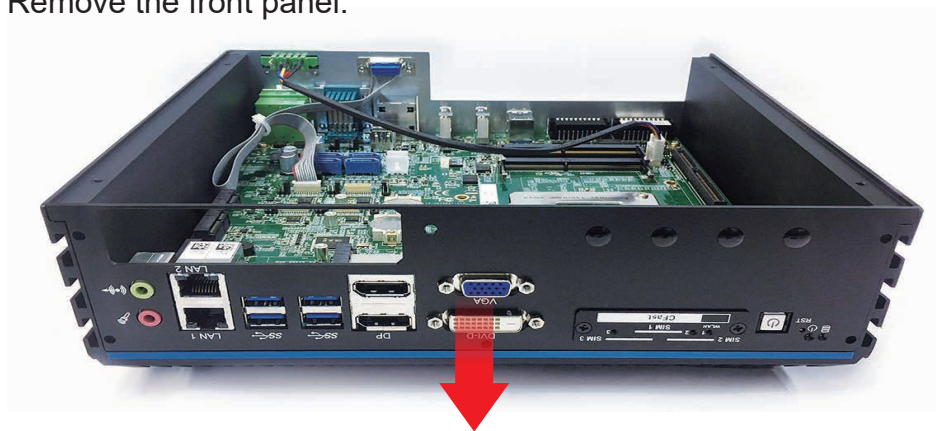

Step 9 Remove four KHS-#6-32 screws on the rear panel.

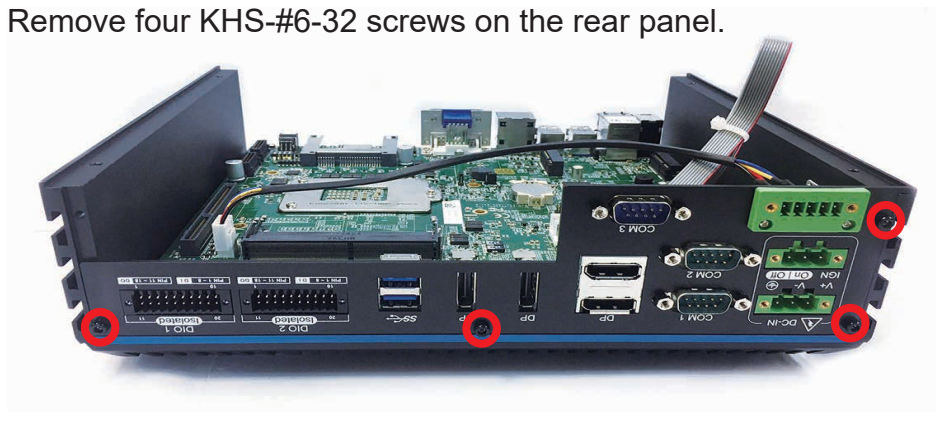

Step 10 Remove the rear panel. (Be careful the cables for COM and Fan)

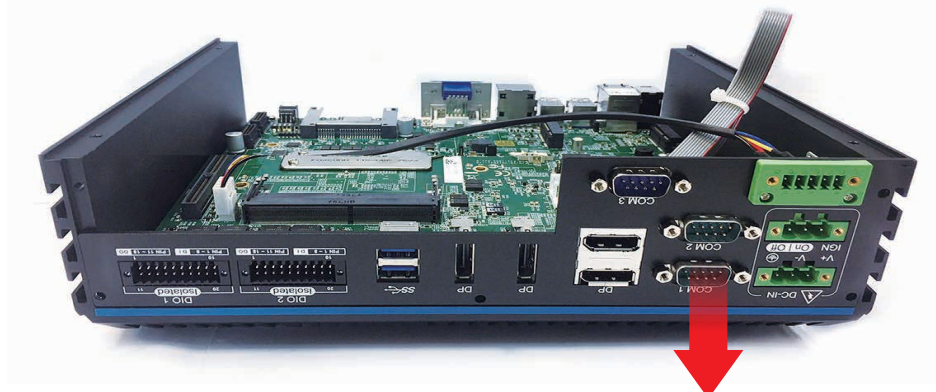

Step 11 Remove seven PH-M3x6L screws.

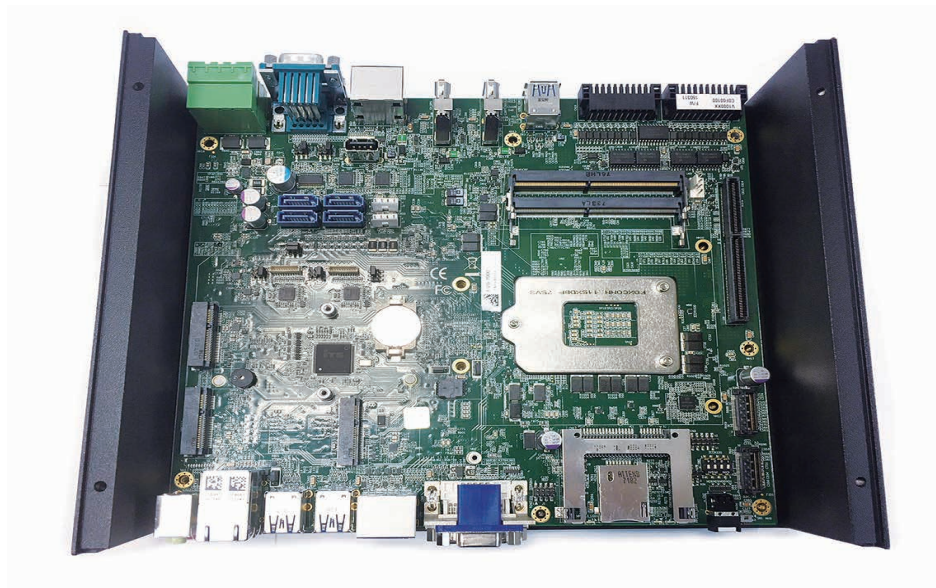
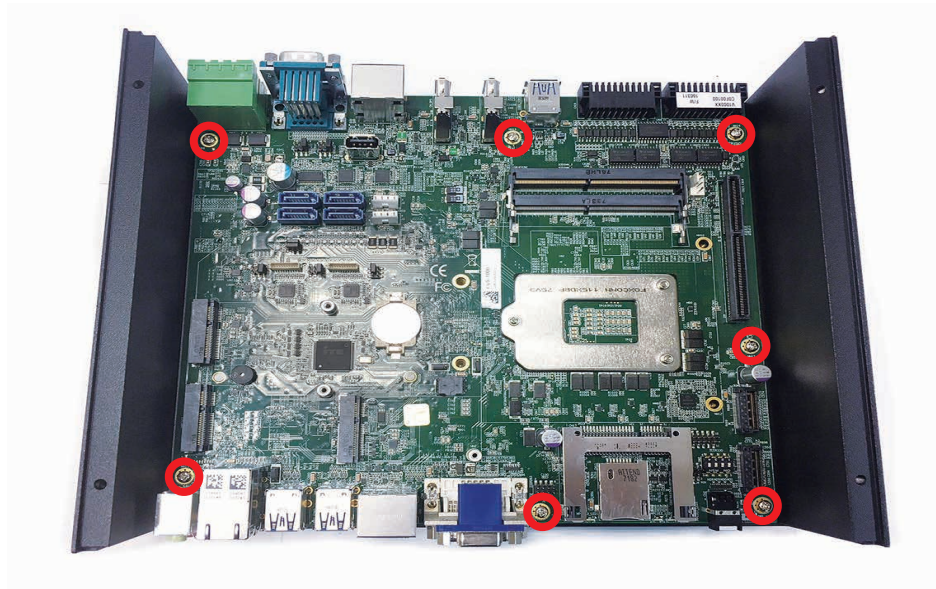

Step 12 Take off the EVS-1000 main board carefully.

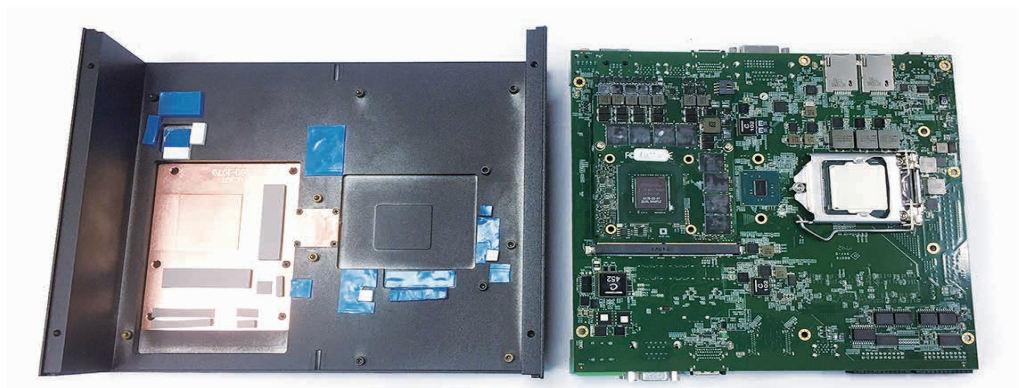

3.2 Installing CPU

Step 1 Keep the CPU socket side up.

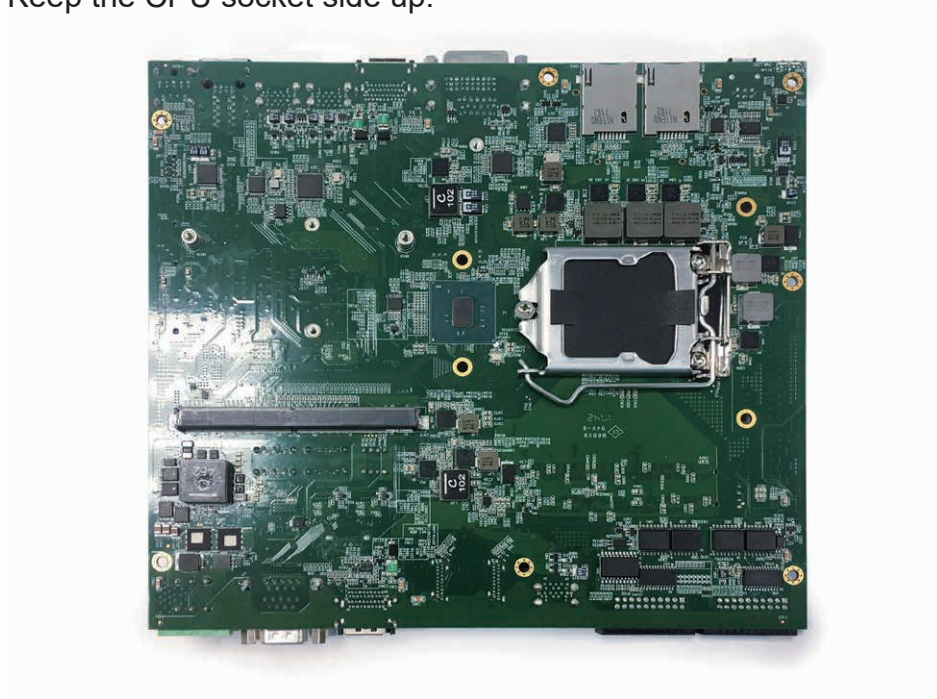

Step 2 Open the cover of CPU socket.

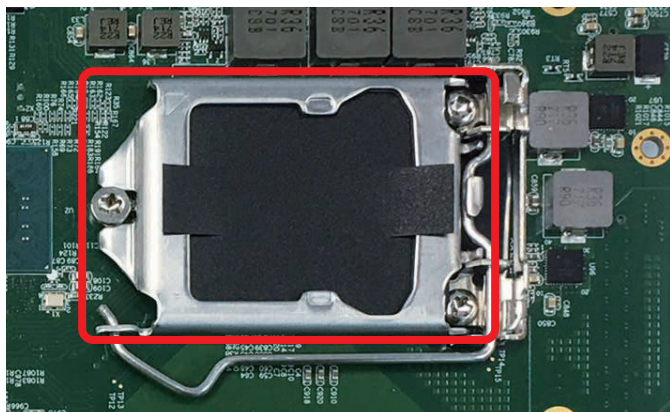

Step 3 Put CPU into the socket.

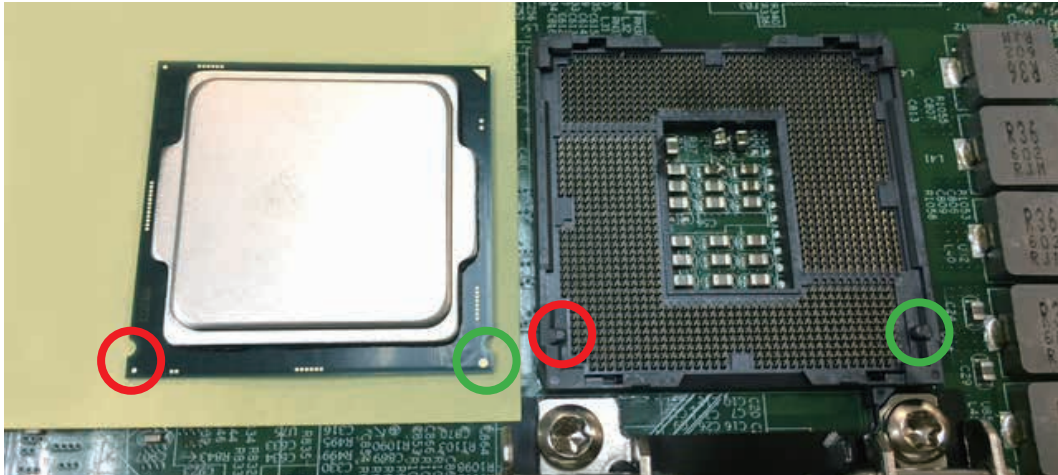

Step 4 Cover and lock the CPU socket.



3.3 Installing DDR4 SO-DIMM Modules

Step 1 Put DDR4 RAM module into SO-DIMM slot.



Step 2 Make sure the RAM module is well locked by the SO-DIMM slot.

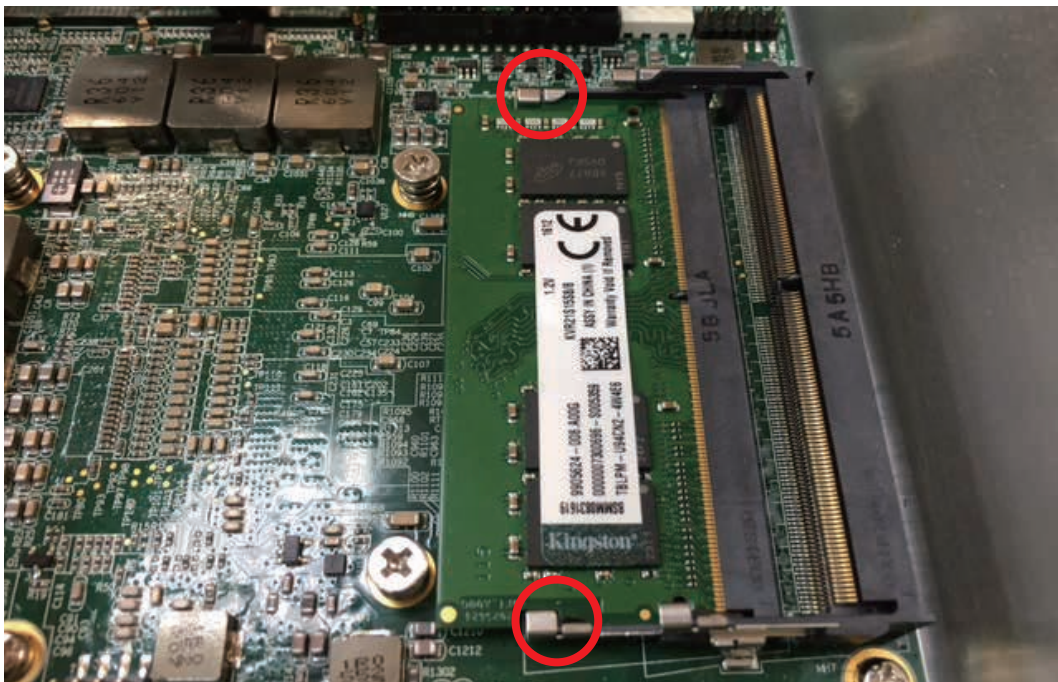

3.4 Installing Mini PCIe Card

Step 1 Put Mini PCIe card into Mini PCIe slot.



Step 2 Fasten one M2.5 screw.



3.5 Installing Antenna Cable

Step 1 Check antenna cable and washers.



Step 2 Remove the rubber corks on the front panel.

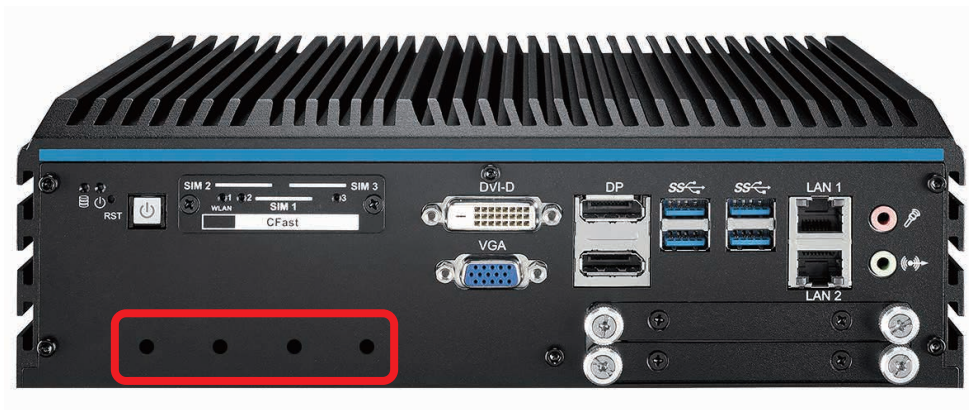

Step 3 Put antenna cable connector into the hole on front panel and fasten washer 1, washer 2, and washer 3 on the antenna cable connector.



3.6 Installing CFast Card

Step 1 Remove two F-M3x4 screws on front panel and then take off the cover of CFast card and SIM card sockets.

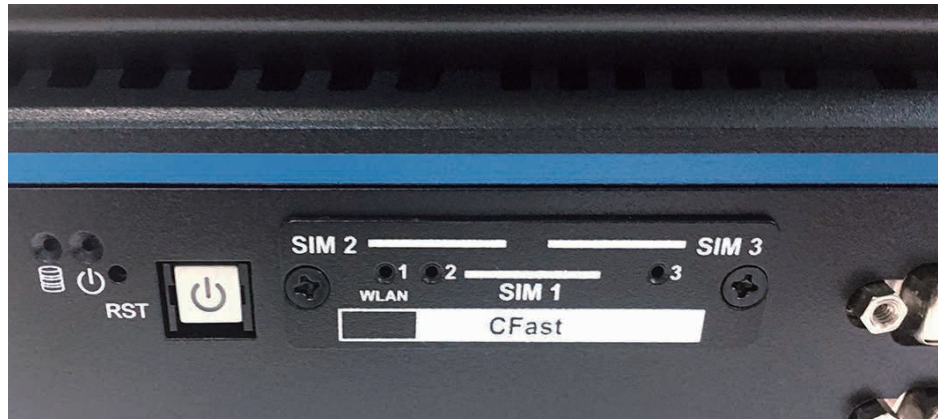

Step 2 Before Inserting CFast, make sure the system power is not plugged.

Step 3 Put CFast card into CFast card socket and then push to lock the card.

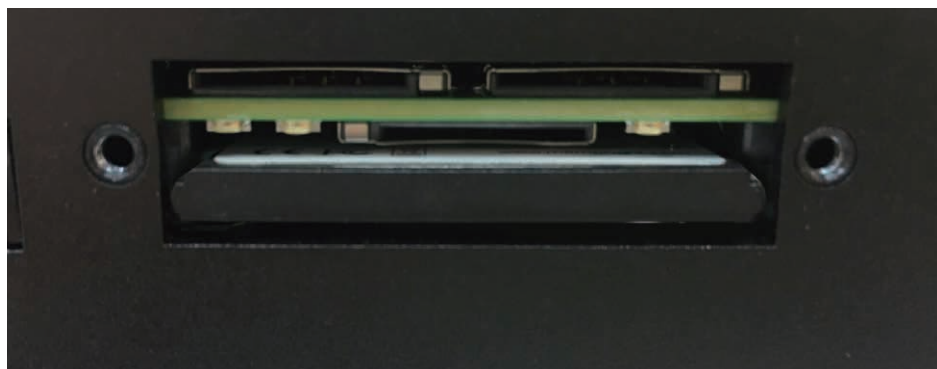
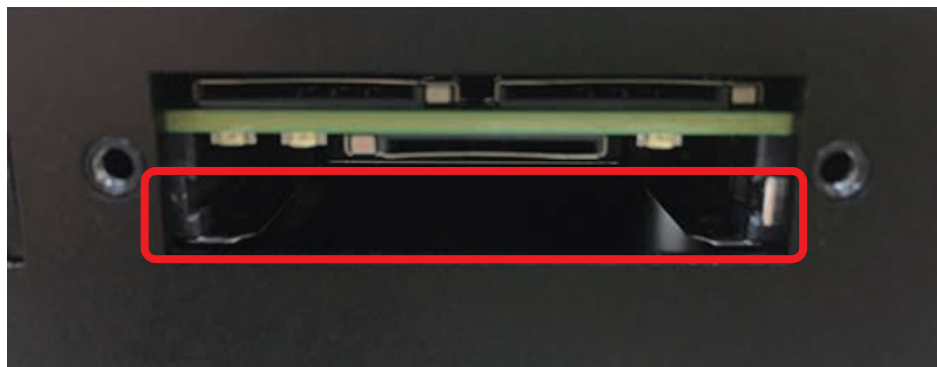

3.7 Installing SIM Card

Step 1 Remove two F-M3x4 screws on front panel and then take off the cover of SIM card and CFast card sockets.

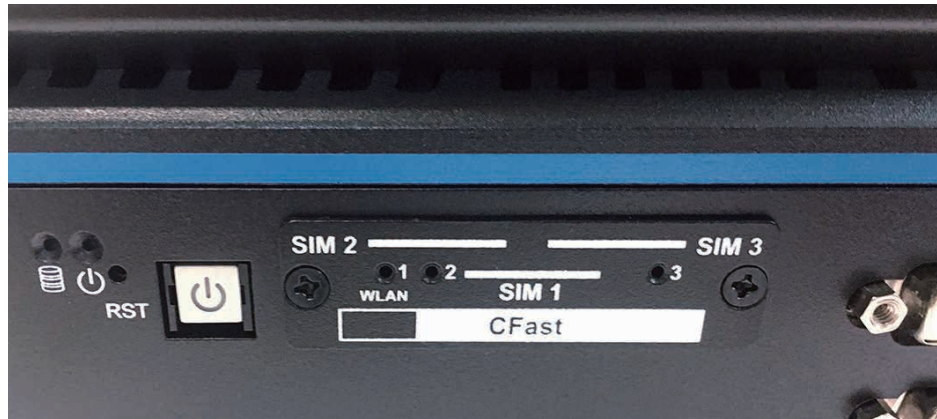

Step 2 Before Inserting SIM Card, make sure the system power is not plugged.

Step 3 Put SIM card into SIM card socket and then push to lock the card.

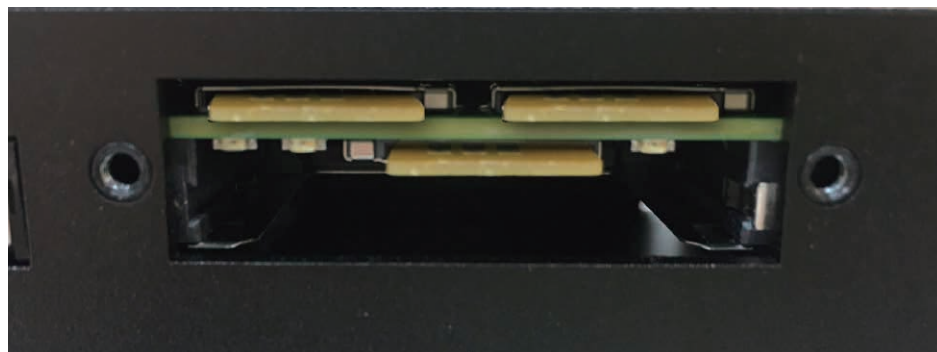
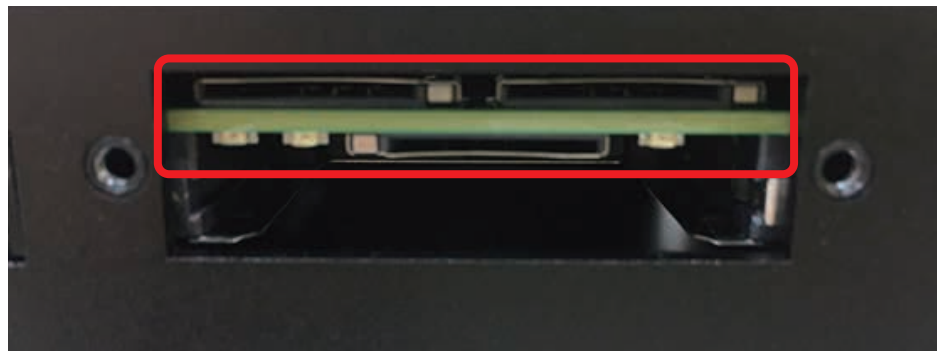

3.8 Installing PCI/PCIe Card

Step 1 Remove the M3 screw on PCI/PCIe tray.



Step 2 Remove the bracket.



Step 3 Match the PCI/PCIe card and the tray.



Step 4 Fasten M3 screw.

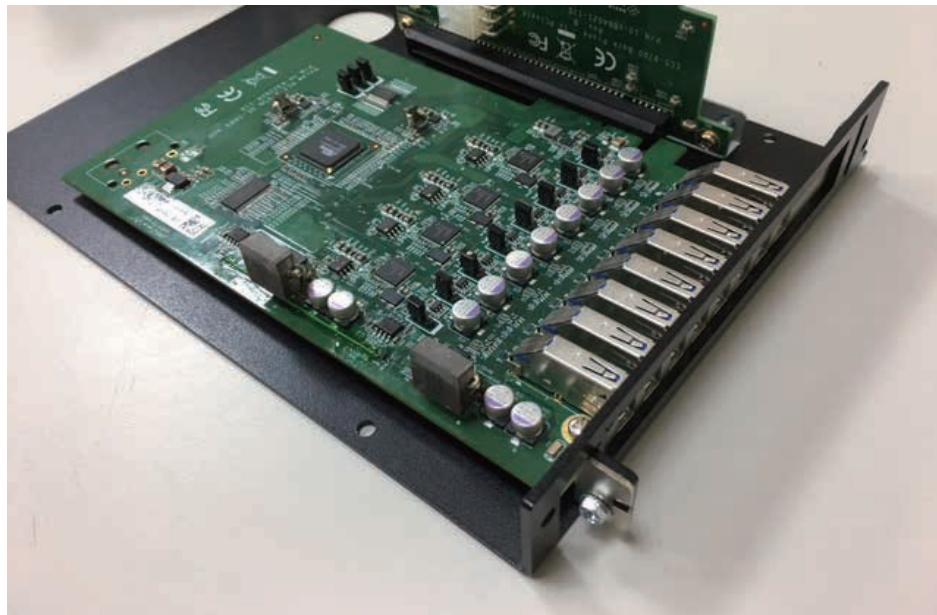

3.9 Installing SSD/HDD

Step 1 Loosen and take out SSD/HDD tray.



Step 2 Match the screw holes on SSD/HDD tray and the 2.5" SSD/HDD.

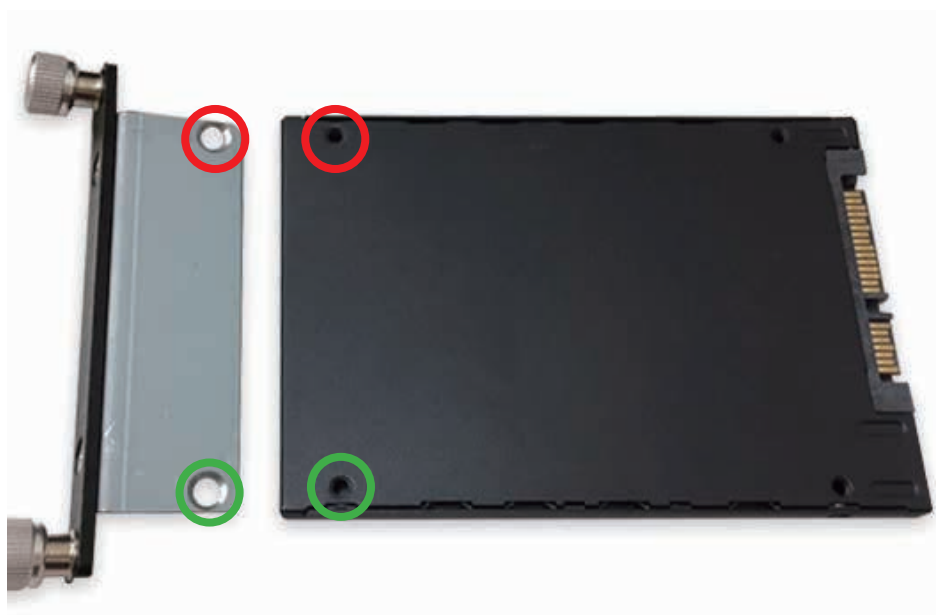

Step 3 Fasten two F-M3x4 screws.

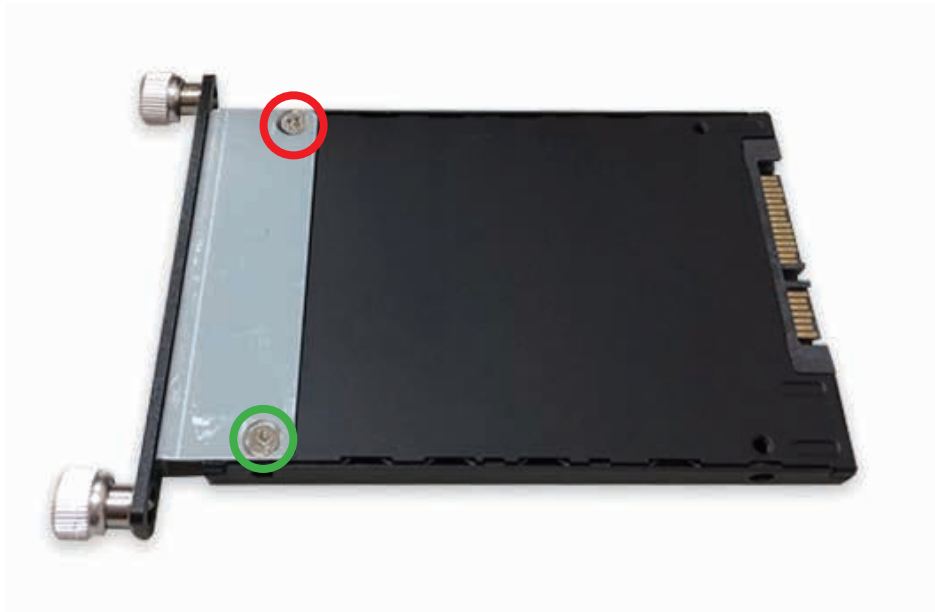

Step 4 Put the SSD/HDD tray back and then power on your EVS-1000/1100.



3.10 Mounting Your EVS-1000/1100

3.10.1 Wall Mount Bracket

Step 1 Ensure the screw holes on the right and left side of upper case match the ones on EVS-1000/1100 wall mount bracket.



Step 2 Fasten four KHS#6-32 screws.



3.10.2 VESA Mount

Step 1 Match EVS-1000/1100 and VESA Mount bracket.

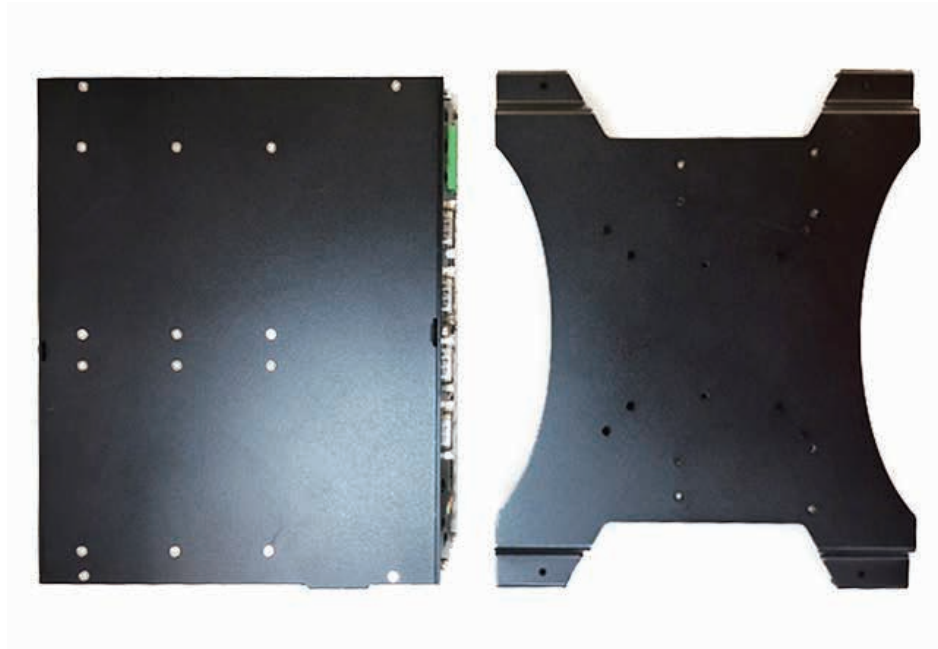

Step 2 Match the 4 screw holes on ECS-1000/1100 and VESA Mount bracket.

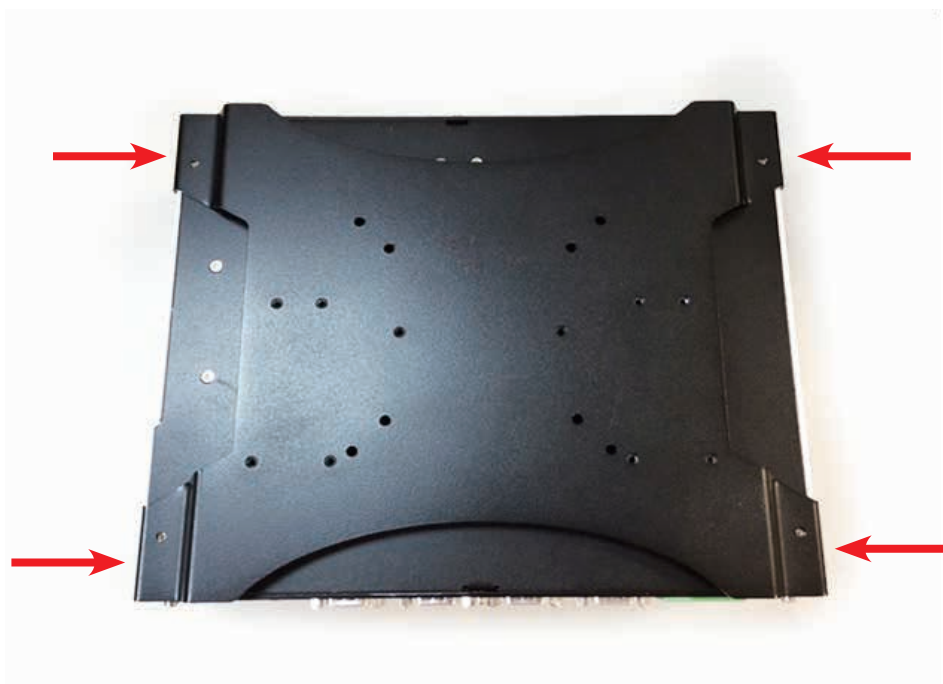



Step 3 Fasten 4pcs KHS#6-32 screws.



Step 4 EVS-1000/1100 VESA Mount bracket supports 75x75mm (marked in red) and 100x100mm (marked in yellow).

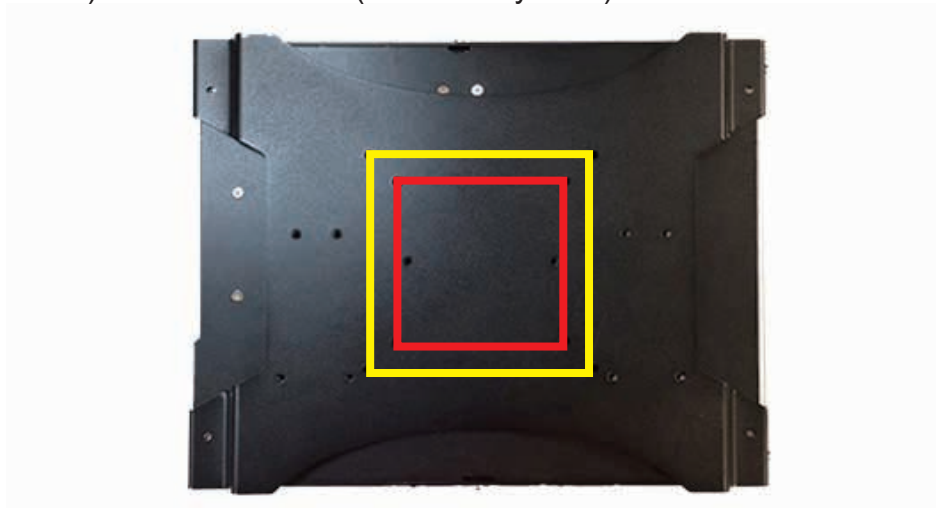

3.10.3 DIN Rail Kit

Step 1 Match EVS-1000/1100 and DIN Rail Kit.



Step 2 Match the 4 screw holes on ECS-1000/1100 and DIN Rail Kit.





Step 3 Fasten 4pcs KHS#6-32 screws.



Step 4 Mount on DIN Rail.



4

BIOS AND DRIVER

4.1 BIOS Settings

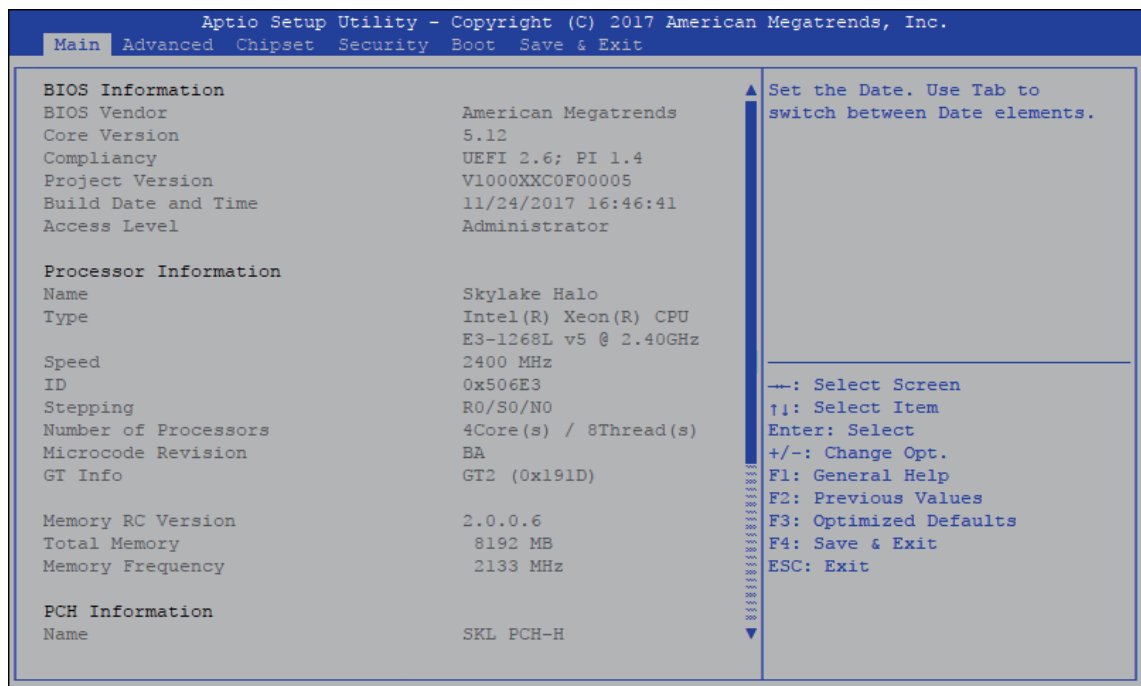

Figure 4-1 : Entering Setup Screen

BIOS provides an interface for users to check and change system configuration. The BIOS setup program is accessed by pressing the key when POST display output is shown.

4.2 Main

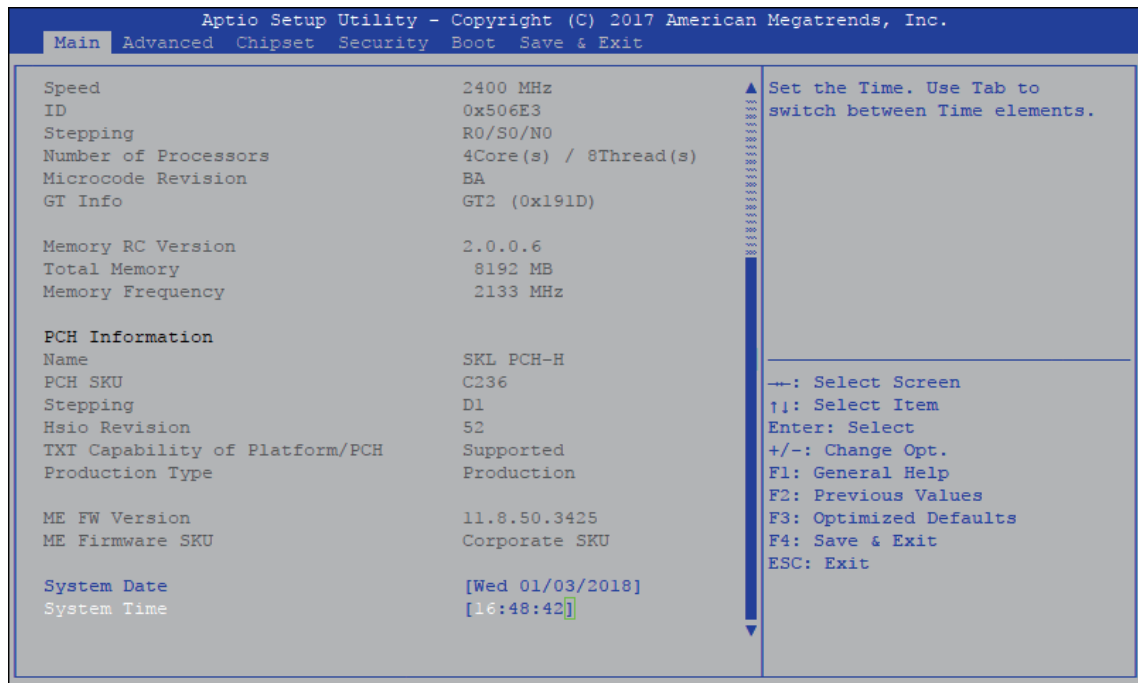

Figure 4-2 : BIOS Main Menu

The main menu displays BIOS version and system information. There are two options on Main menu.

System Date

Set the date. Use <Tab> to switch between date elements.

System Time

Set the time. Use <Tab> to switch between time elements.

4.3 Advanced

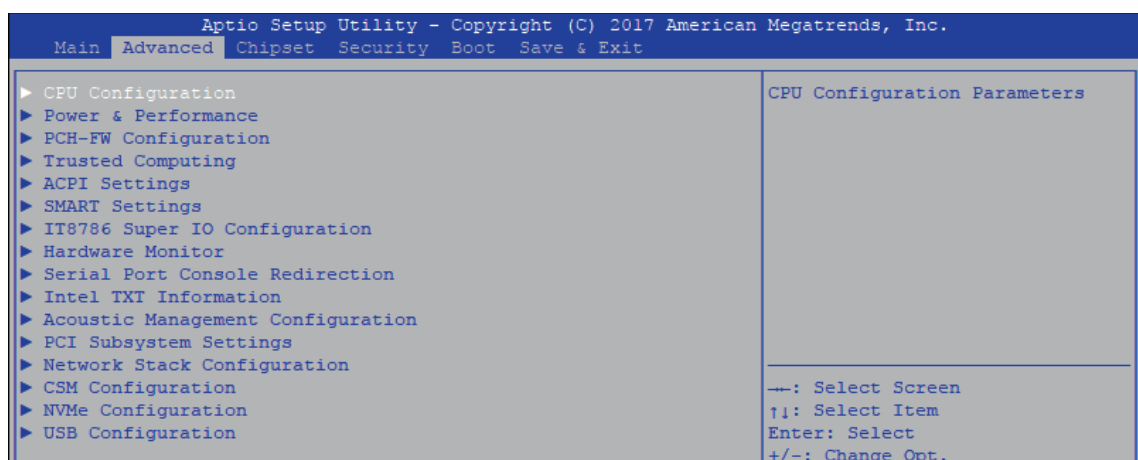

Figure 4 3 : BIOS Advanced Menu

Select advanced tab to enter advanced BIOS setup options, such as CPU configuration, SATA configuration, and USB configuration.

4.3.1 CPU Configuration

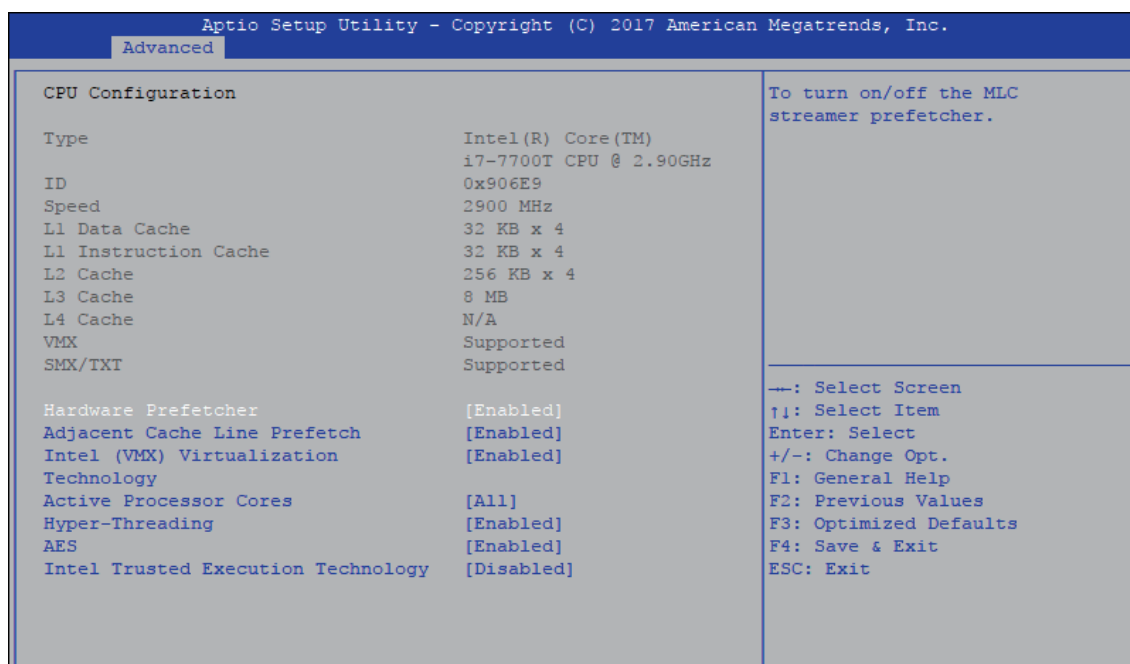

Figure 4 3-1 : CPU Configuration

Hardware Prefetcher

To turn on/off the MLC streamer prefetcher.

Adjacent Cache Line Prefetch

To turn on/off prefetching of adjacent cache lines.

Intel (VMX) Virtualization Technology

When enabled, a VMM can utilize the additional hardware capabilities provided by Vanderpool Technology.

Active Processor Cores

Number of cores to enable in each processor package.

Hyper-threading

Enabled for Windows XP and Linux (OS optimized for Hyper-Threading Technology) and disabled for other OS (OS not optimized for Hyper-Threading Technology). When disabled only one thread per core is enabled.

AES

Enable/disable CPU Advanced Encryption Standard instructions.

Intel Trusted Execution Technology

Enables utilization of additional hardware capabilities provided by Intel® Trusted Execution Technology.

Changes require a full power cycle to take effect.

4.3.2 Power & Performance

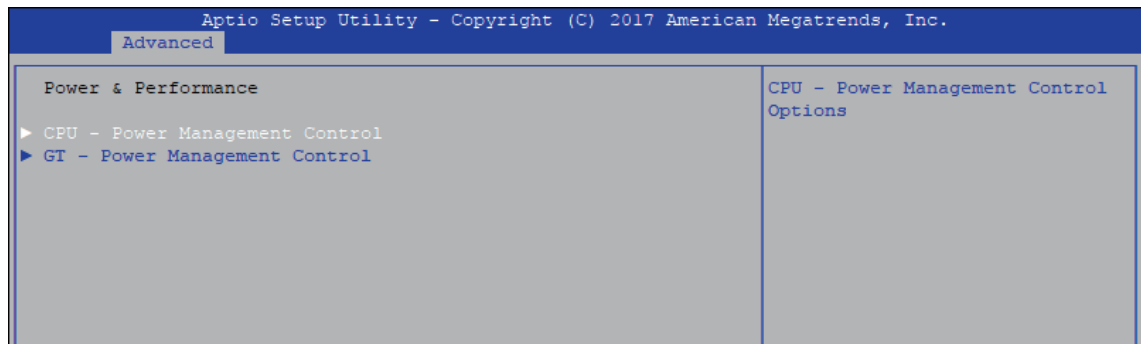

Figure 4 3-2 : Power & Performance

4.3.2.1 CPU – Power Management Control

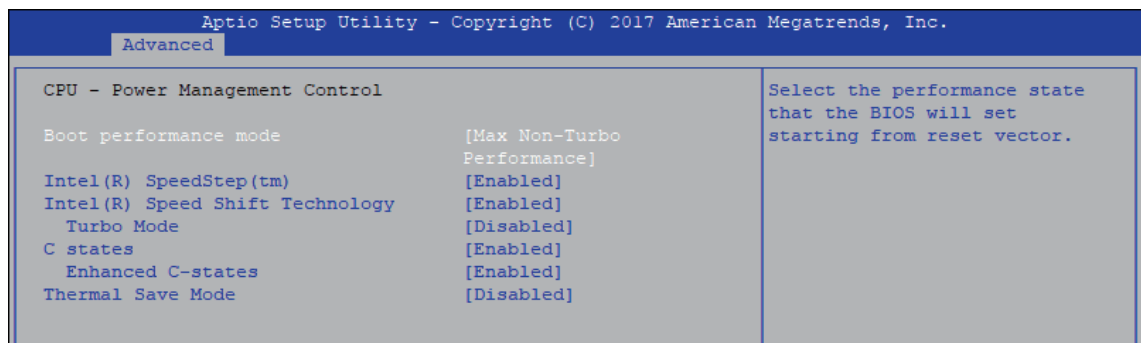

Figure 4 3-2-1 : CPU – Power Management Control

Boot performance mode

Select the performance state that the BIOS will set before OS handoff.

Intel (R) SpeedStep (tm)

Allows more than two frequency ranges to be supported.

Intel (R) Speed shift Technology

Enable/Disable Intel® Speed Shift Technology support. Enabling will expose the CPPCv2 interface to allow for hardware controlled P-states.

Turbo Mode

Turbo Mode.

C states

Enable or disable CPU C states.

Enhanced C-states

Enable/Disable C1E. When enabled, CPU will switch to minimum speed when all cores enter C-State.

Thermal Save Mode

Enable/Disable Thermal Save Mode support.

4.3.2.2 GT – Power Management Control

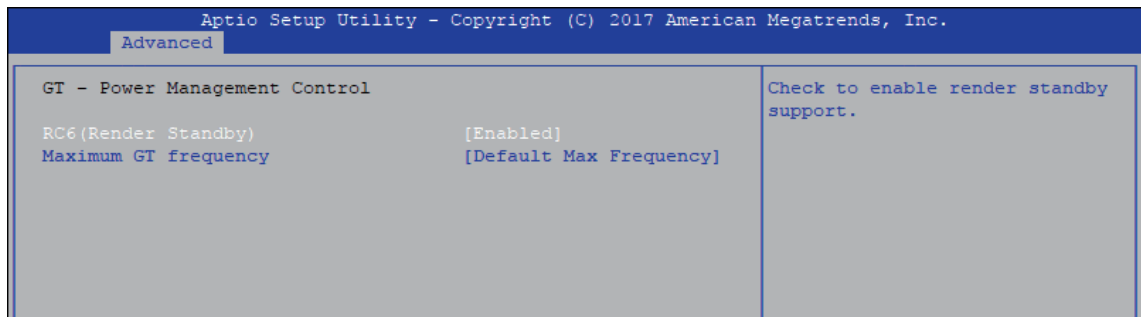

Figure 4 3-2-2 : GT – Power Management Control

RC6 (Render Standby)

Check to enable render standby support.

Maximum GT frequency

Maximum GT frequency limited by the user. Choose between 350MHz (RPN) and 1150MHz (RP0). Value beyond the range will be clopped to min/max supported by SKU

4.3.3 GT – Power Management Control



Figure 4 3-3 : PCH-FW Settings

ME State

Set ME to Soft temporarily disabled.

AMT BIOS Features

When disabled AMT BIOS Features are no longer supported and user is no longer able to access MEBx Setup.

AMT Configuration

Configure Intel® Active Management Technology Parameters.

ME Unconfig on RTC Clear State

Disabling this option will cause ME not to unconfigure on RTC clear.

4.3.4 Trusted Computing

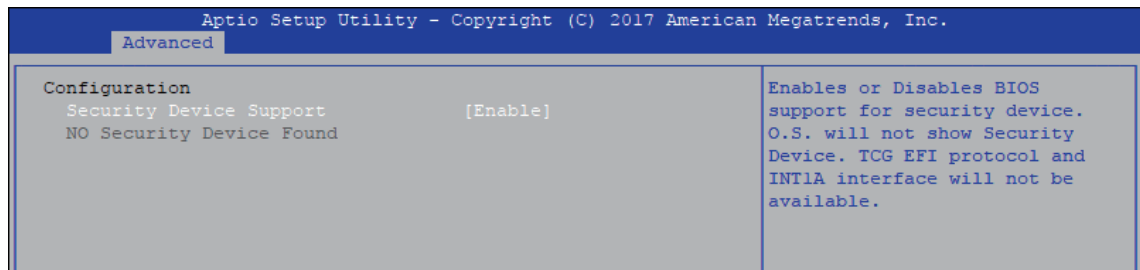

Figure 4 3-4 : Trusted Computing

Control the TPM device status and display related information if TPM chip is present.

4.3.5 ACPI Settings

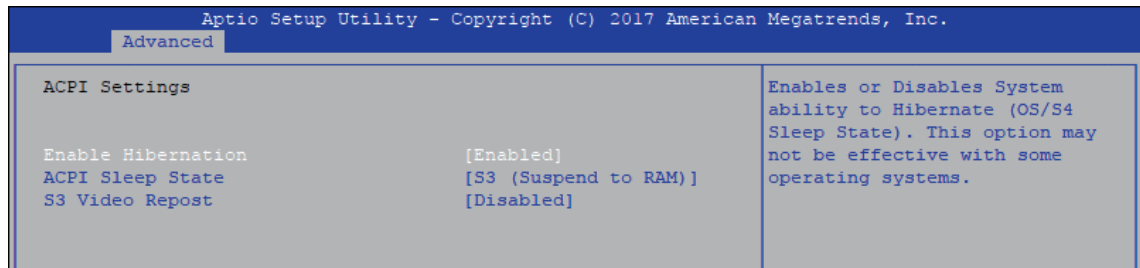

Figure 4 3-5 : ACPI Settings

Enable Hibernation

Enables or disables system's ability to hibernate (OS/S4 sleep state). This option may not be effective with some OS.

ACPI Sleep State

Selects the highest ACPI sleep state the system will enter when the SUSPEND button is pressed.

S3 Video Repost

Enables or disables S3 video repost.

4.3.6 SMART Settings

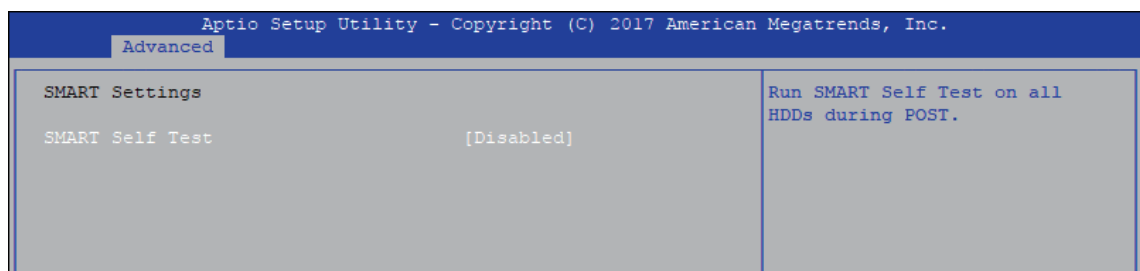

Figure 4-3-6 : SMART Settings

SMART Self Test

Run SMART self test on all HDDs during POST.

4.3.7 IT8786 Super IO Configuration

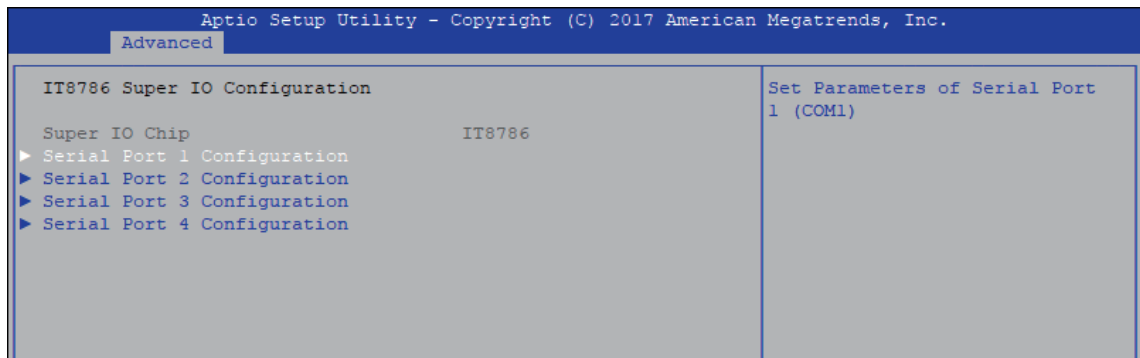

Figure 4-3-7 : IT8786 Super IO Settings

4.3.7.1 Serial Port X Configuration

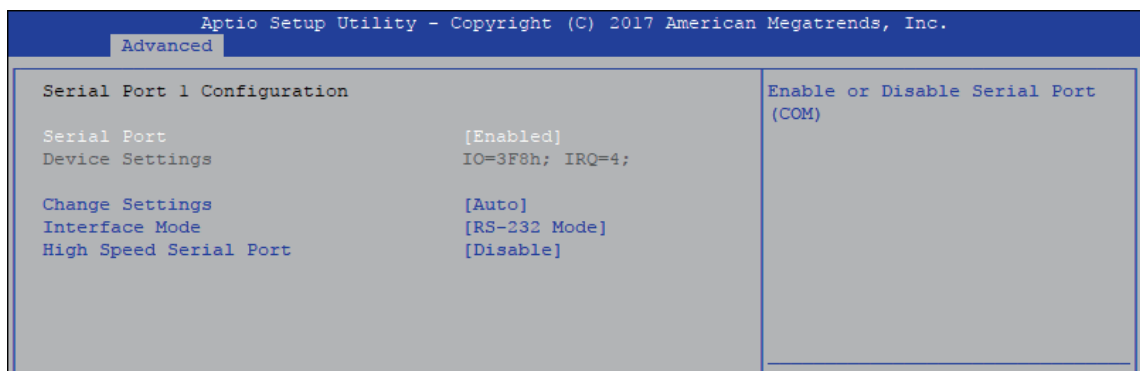

Figure 4-3-7-1 : Serial Port X Configuration

Serial Port 1 to port 4 Configuration

Options for Serial Port 1 to Serial Port 4.

Entering the corresponding Port option then end user can change the settings such as I/O resource and UART mode (High Speed Serial Port is Port 1 only).

4.3.8 Hardware Monitor

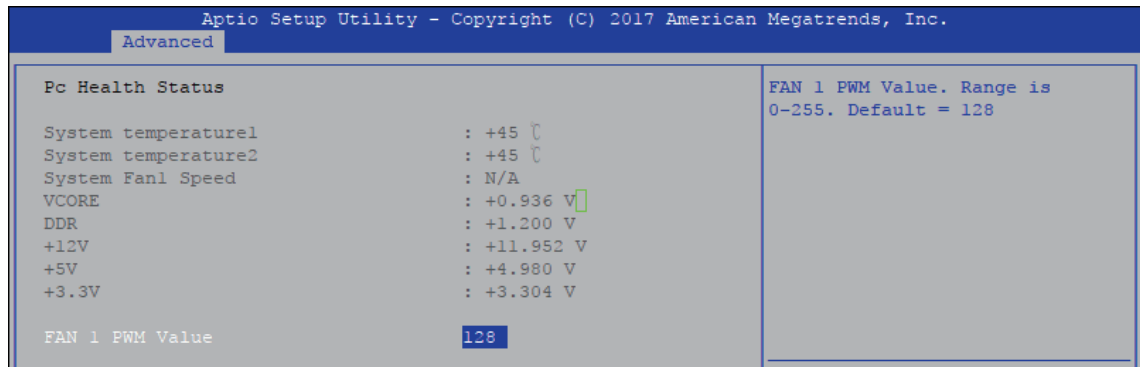

Figure 4-3-8 : Hardware Monitor Settings

The IT8786 SIO features an enhanced hardware monitor providing thermal, fan speed, and system voltages' status monitoring.

Fan 1 PWM Value

FAN 1 PWM Value. Range is 0-255. Default =128, the higher value means more RPM
FAN1 PWM example :

- 100% → 255
- 90% → 230
- 80% → 204
- 70% → 179
- 60% → 153
- 50% → 128
- 40% → 102
- 30% → 77
- 20% → 51
- 10% → 26

4.3.9 Serial Port Console Redirection



Figure 4-3-9 : Serial Port Console Redirection Settings

Console Redirection

Console redirection enable or disable.

Console Redirection Settings

These settings specify how the host computer and the remote computer (which the user is using) will exchange data. Both computers should have the same or compatible settings.

4.3.10 Intel TXT Information

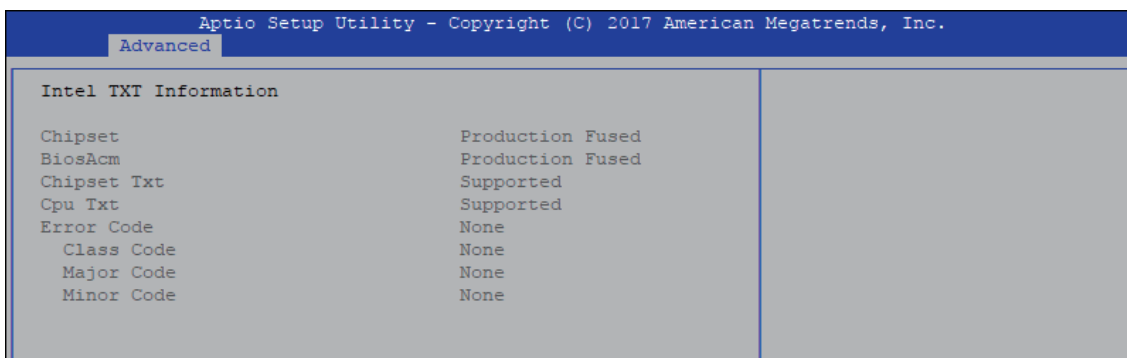

Figure 4-3-10 : Intel TXT Information

Display Intel TXT information

4.3.11 Acoustic Management Configuration

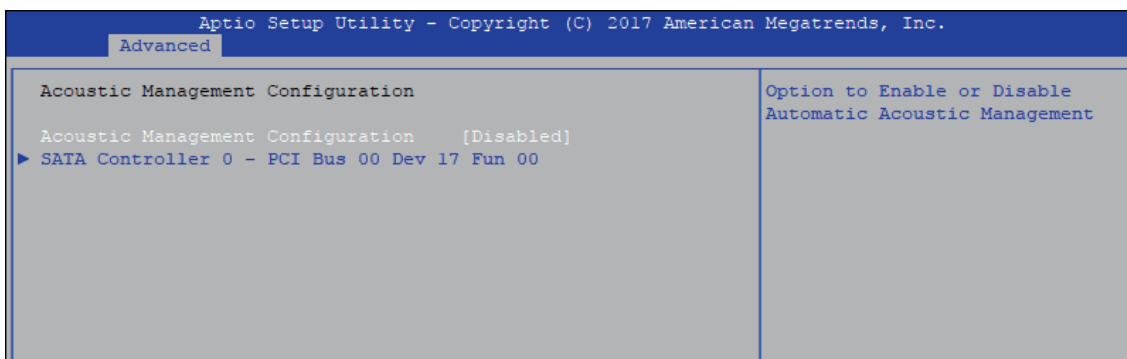

Figure 4-3-11 : Acoustic Management Settings

Acoustic Management Configuration

Option to enable or disable automatic acoustic management.

4.3.12 PCI Subsystem Setting



Figure 4-3-12 : PCI Subsystem Settings

Above 4G Decoding

Globally Enables or Disables 64-bit capable Devices to be Decoded in Above 4G Address Space (Only if System Supports bot PCI Decoding)

4.3.13 Network Stack Configuration

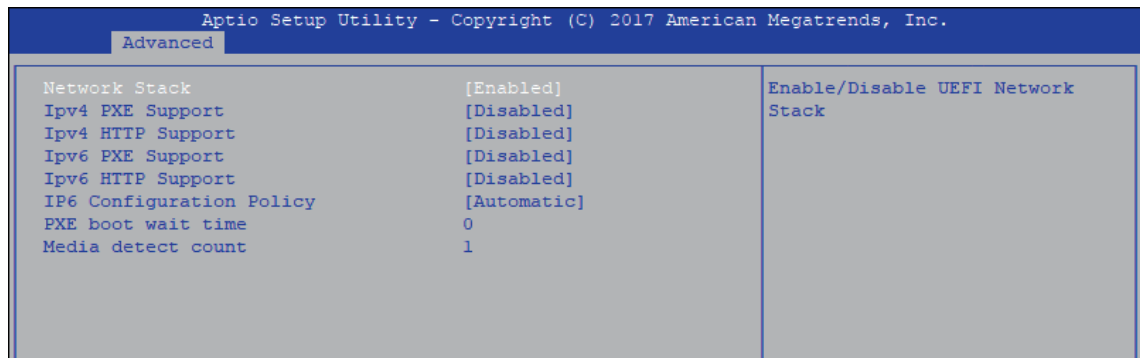

Figure 4-3-13 : Network Stack Settings

Network Stack

Enable/Disable UEFI Network Stack.

Ipv4 PXE Support

Enable/Disable IPv4 PXE boot support.

Ipv4 HTTP Support

Enable/Disable IPv4 HTTP boot support.

Ipv6 PXE Support

Enable/Disable IPv6 PXE boot support.

Ipv6 HTTP Support

Enable/Disable IPv6 HTTP boot support.

IP6 Configuration Policy

Set IP6 Configuration Policy.

PXE boot wait time

Wait time to press ESC key to abort the PXE boot.

Media detect count

Number of times presence of media will be checked.

4.3.14 CSM Configuration

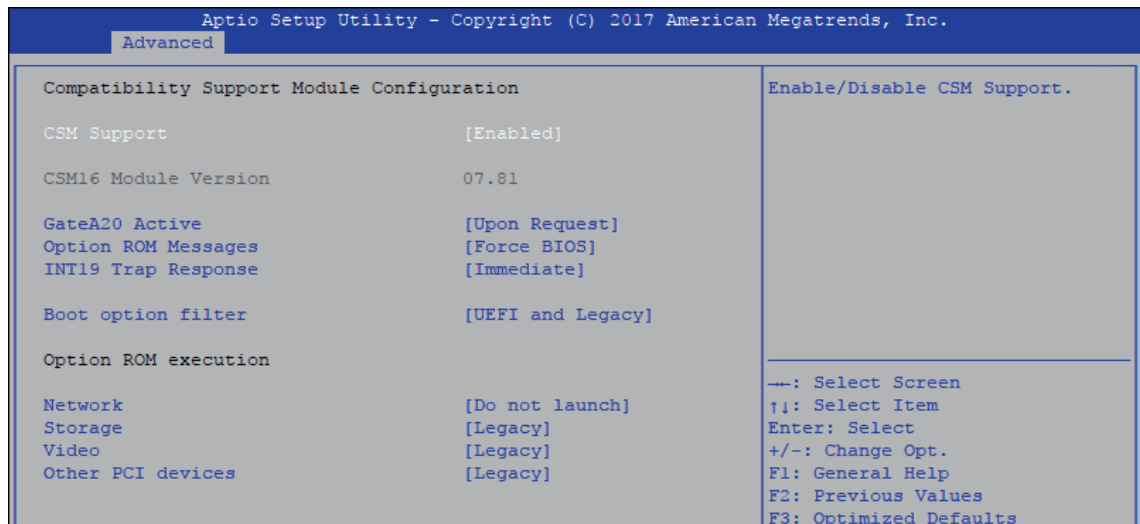

Figure 4-3-14 : CSM Settings

CSM Support

Enable/Disable CSM support.

GateA20 Active

UPON REQUEST - GA20 can be disabled using BIOS services.

ALWAYS - do not allow GA20 to be disabled; this option is useful when any RT code is executed above 1MB.

Option ROM Messages

Set display mode for Option ROM.

INT19 Trap Response

BIOS reaction on INT19 trapping by Option ROM :

IMMEDIATE - execute the trap right away;

POSTPONED - execute the trap during legacy boot.

Boot option filter

This option controls Legacy/UEFI ROM's priority.

Network

Controls the execution of UEFI and Legacy PXE OpROM.

Storage

Controls the execution of UEFI and Legacy Storage OpROM.

Video

Allows more than two frequency ranges to be supported.

Other PCI devices

Determines OpROM execution policy for devices other than network, storage, or video.

4.3.15 NVMe Configuration

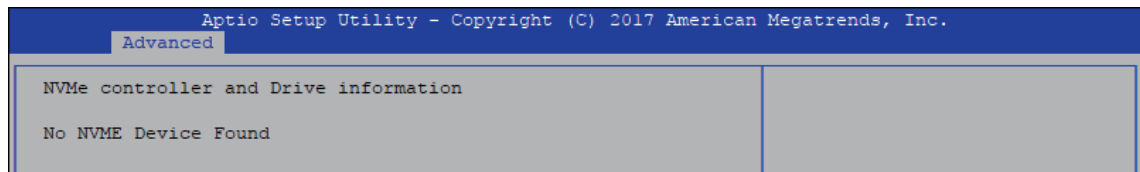

Figure 4-3-15 : NVMe Settings

4.3.16 USB Configuration

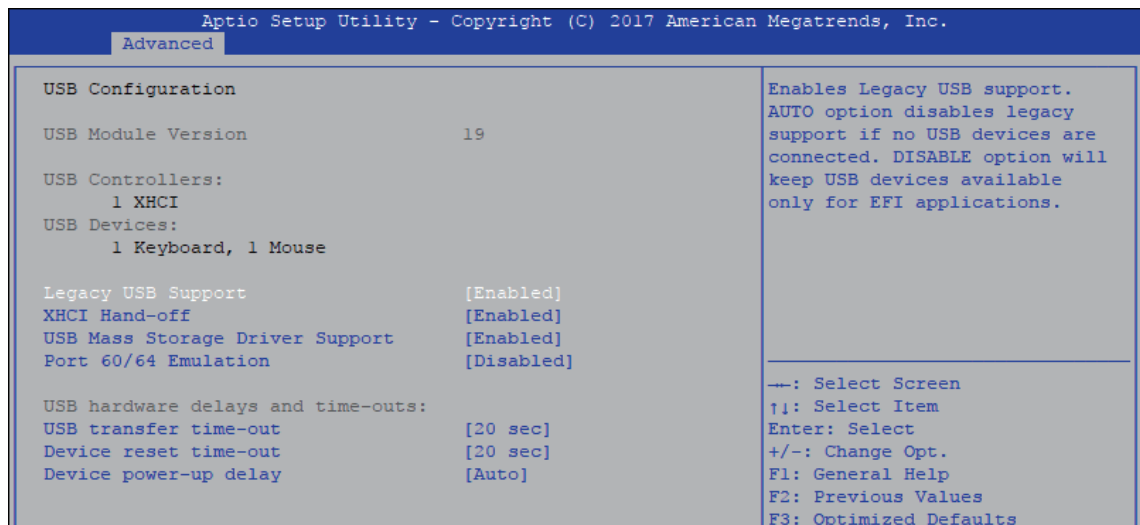

Figure 4-3-16 : USB Settings

Legacy USB Support

Enables Legacy USB support.

AUTO option disables Legacy support if no USB devices are connected.

DISABLE option will keep USB devices available only for EFI applications.

XHCI Hand-off

This is a workaround for OS-es without XHCI hand-off support. The XHCI ownership change should be claimed by XHCI driver.

USB Mass Storage Driver Support

Enable/disable USB mass storage driver support.

Port 60/64 Emulation

Enables I/O port 60h/64h emulation support. This should be enabled for the complete USB keyboard legacy support for non-USB aware OSes.

USB transfer time-out

The time-out value for control, bulk, and interrupt transfers.

Device reset time-out

USB mass storage device start unit command time-out.

Device power-up delay

Maximum time the device will take before it properly reports itself to the Host Controller. 'Auto' uses default value, for a root port it is 100 ms, for a hub port the delay is taken from the hub descriptor.

4.4 Chipset

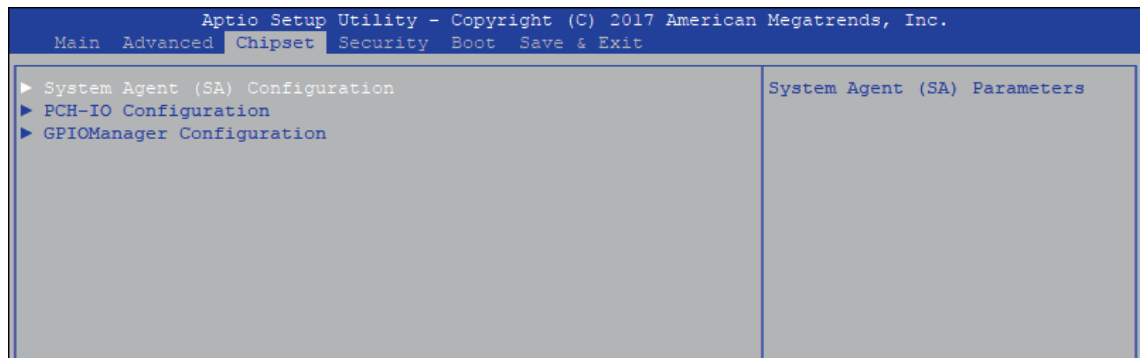

Figure 4-4 : BIOS Chipset Menu

System Agent (SA) Configuration

System Agent (SA) parameters.

PCH-IO Configuration

PCH parameters.

GPIOManager Configuration

GPIOManager Configuration.

4.4.1 System Agent (SA) Configuration



Figure 4-4-1 : System Agent Settings

VT-d

VT-d capability.

GMM Device (B0 : D8 : F0)

Enable/Disable SA GMM device.

Above 4GB MMIO BIOS assignment

Enable/Disable above 4GB MemoryMappedIO BIOS assignment. This is disabled automatically when aperture size is set to 2048MB.

4.4.1.1 Memory Configuration

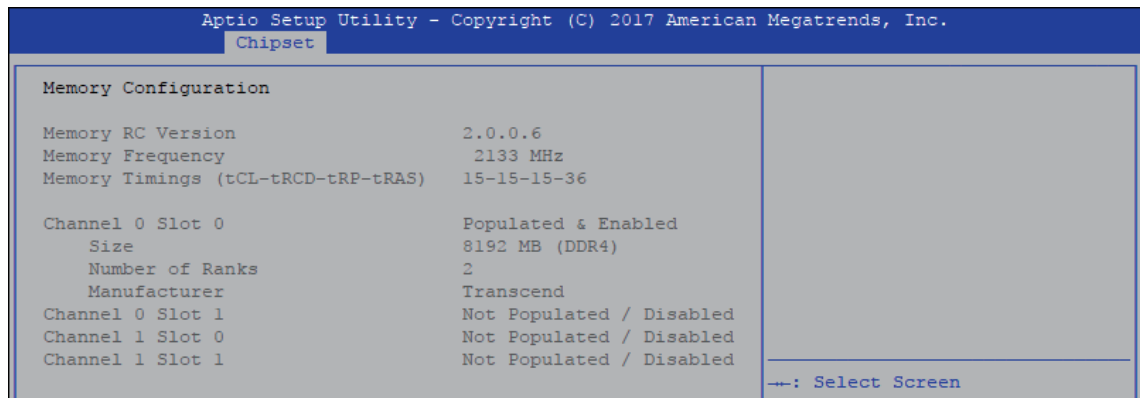

Figure 4-4-1-1 : Memory Information

Displays memory information.

4.4.1.2 Graphics Configuration

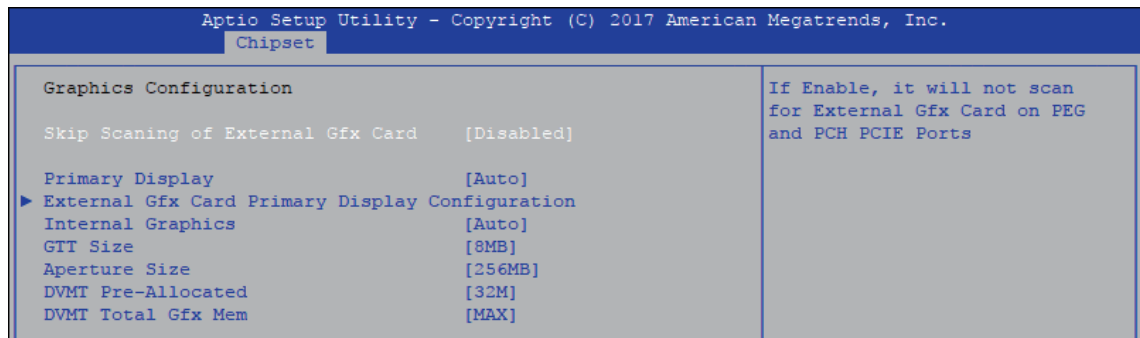

Figure 4-4-1-2 : Graphics Settings

Skip Scanning of External Gfx Card

If Enable, it will not scan for External Gfx Card on PEG and PCH PCIE Ports.

Primary Display

Select which of IGFX/PEG/PCI Graphics device should be Primary Display Or select SG for Switchable Gfx.

Internal graphics

Keep IGFX enabled based on the setup options.

GTT Size

Select the GTT Size.

Aperture Size

Select the Aperture Size.

Note : Above 4GB MMIO BIOS assignment is automatically enabled when selecting 2048MB aperture. To use this feature, please disable CSM Support.

DVMT Pre-Allocated

Select DVMT 5.0 Pre-Allocated (Fixed) Graphics Memory size used by the Internal Graphics Device.

DVMT Total Gfx Mem

Select DVMT5.0 Total Graphic Memory size used by the Internal Graphics Device.

4.4.1.3 PEG Port Configuration



Figure 4-4-1-3 : PEG Port Configuration

PEG port options for PCIe device.

4.4.2 PCH-IO Configuration

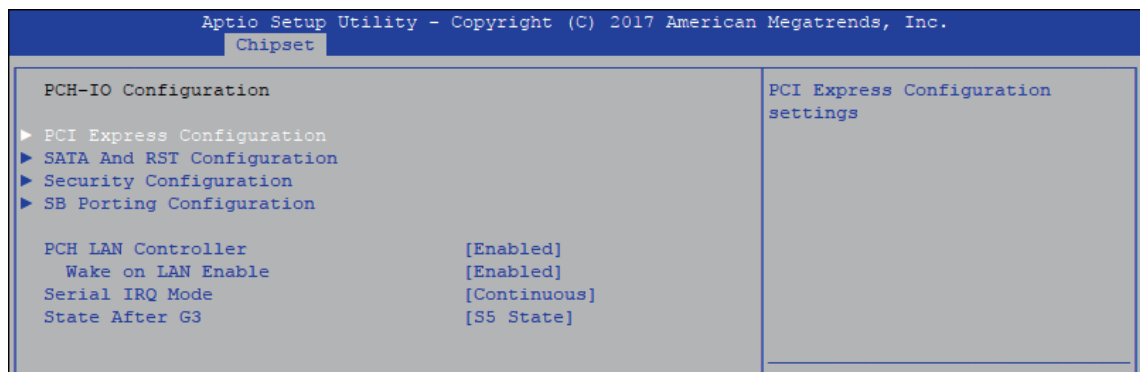

Figure 4-4-2 : PCH-IO Settings

PCH LAN Controller

Enable or disable onboard NIC.

Wake on LAN

Enable or disable integrated LAN to wake the system. (The wake On LAN cannot be disabled if ME is on at Sx state.)

Serial IRQ Mode

Configure serial IRQ mode.

State After G3

Specify what state to go to when power is re-applied after a power failure (G3 state).

S0 State : Always turn-on the system when power source plugged-in.

S5 State : Always turn-off the system when power source plugged-in.

4.4.2.1 PCI Express Configuration of PCH-IO

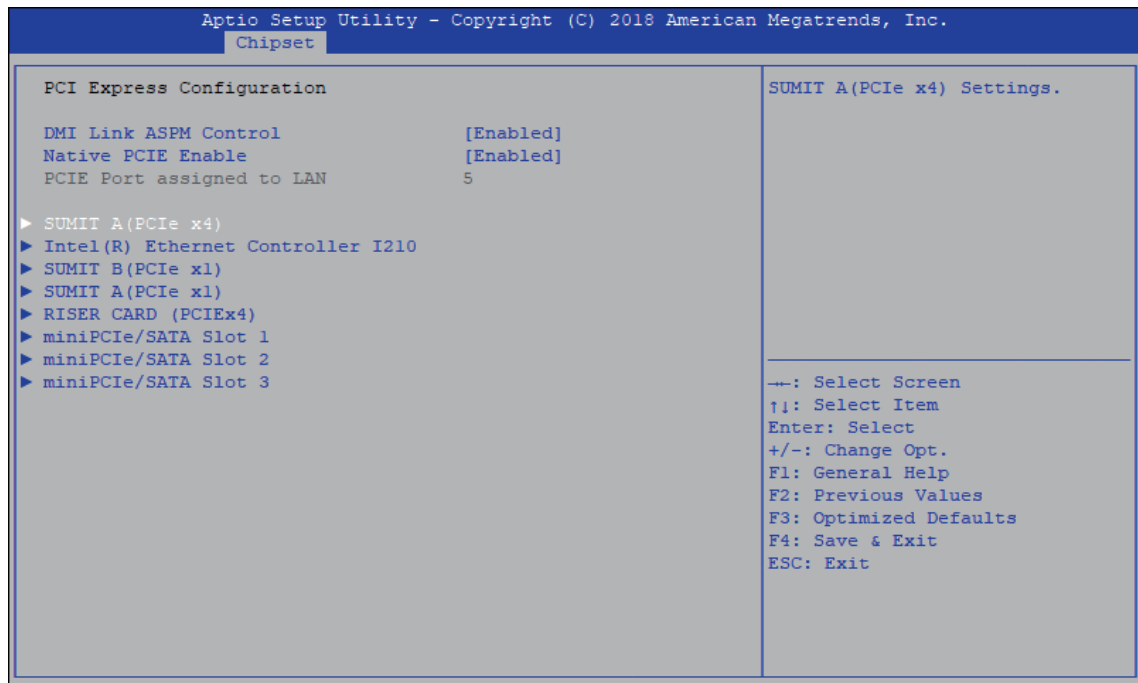

Figure 4-4-2-1 : PCH-IO Settings

DMI Link ASPM Control

Enable/Disable the control of Active State Power Management on SA side of the DMI Link.

Native PCIE Enable

PCIE Express Native Support Enable/Disable.

SUMIT A (PCIe x4)

Bios options for PCIe devices on SUMIT A Slot.

Intel® Ethernet Controller I210

Bios options for PCIe device on Intel® Ethernet Controller I210 LAN.

SUMIT B (PCIe x1)

Bios options for PCIe devices on SUMIT B Slot.

SUMIT A (PCIe x1)

Bios options for PCIe devices on SUMIT A Slot.

RISER CARD (PCIe x4)

Bios options for PCIe device on Riser Card Slot

Mini PCIe Slot 1~3

Bios options for PCIe devices on Mini PCIe Slot.

4.4.2.2 SATA and RST Configuration

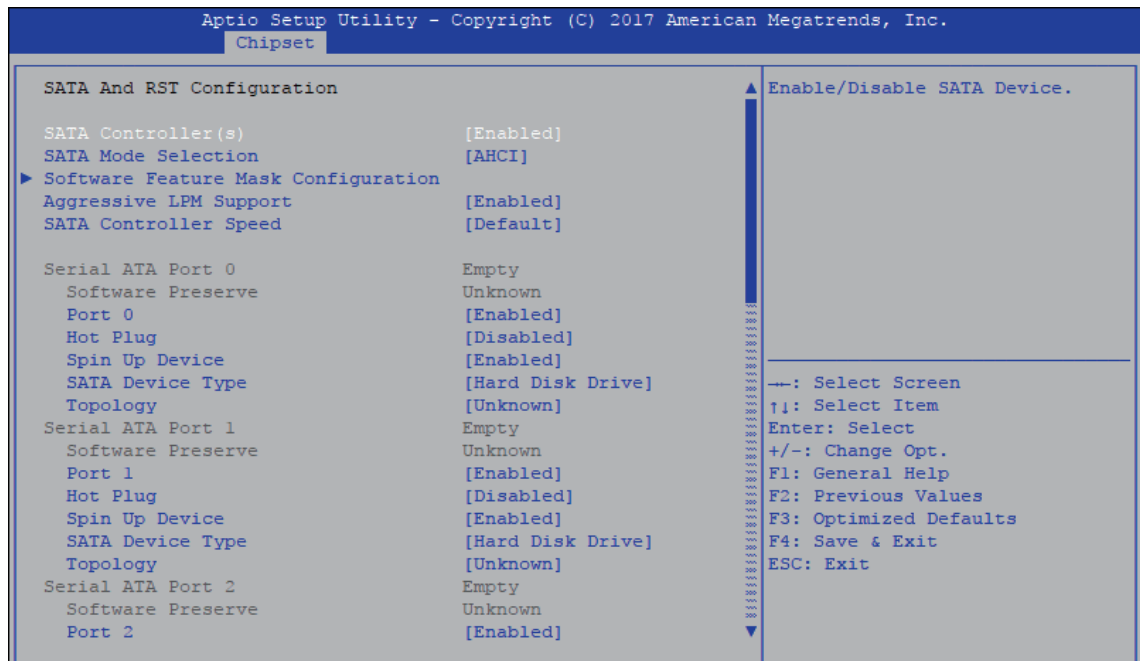

Figure 4-4-2-2 : SATA And RST Settings

SATA Controller (s)

Enable or disable SATA Device.

SATA Mode Selection

Determines how SATA controller (s) operate.

Software Feature Mask Configuration

RAID OROM/RST driver will refer to the SWFM configuration to enable or disable the storage features.

Aggressive LPM Support

Enable PCH to aggressively enter link power state.

SATA Controller Speed

Indicates the maximum speed the SATA controller can support.

Options for each SATA port :

Port n

Enable or disable SATA Port.

Hot Plug

Designated this port as Hot Pluggable.

Spin Up Device

On an edge detect from 0 to 1, the PCH starts a COMRESET initialization sequence to the device.

SATA Device Type

Identifies that the SATA port is connected to solid state drive or hard disk drive.

Topology

Identify the SATA Topology if it is Default or ISATA or Flex or DirectConnect or M2.

4.4.2.3 Security Configuration

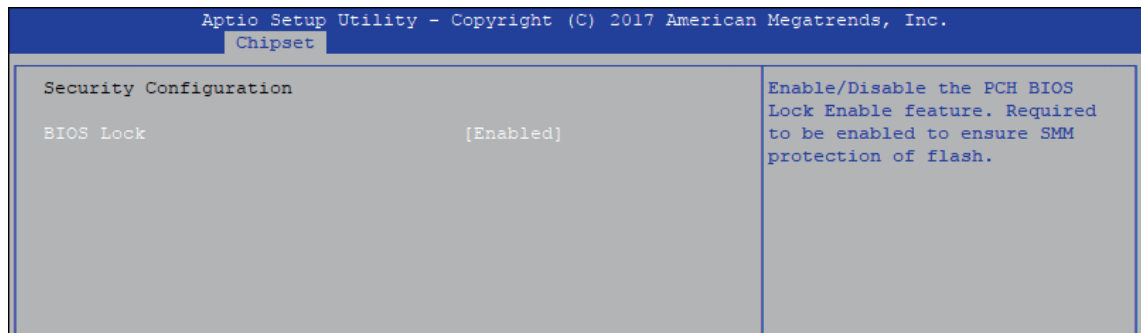

Figure 4-4-2-3 : Security Settings

BIOS Lock

Enable/Disable the PCH BIOS Lock Enable (BLE bit) feature.

4.5 Security

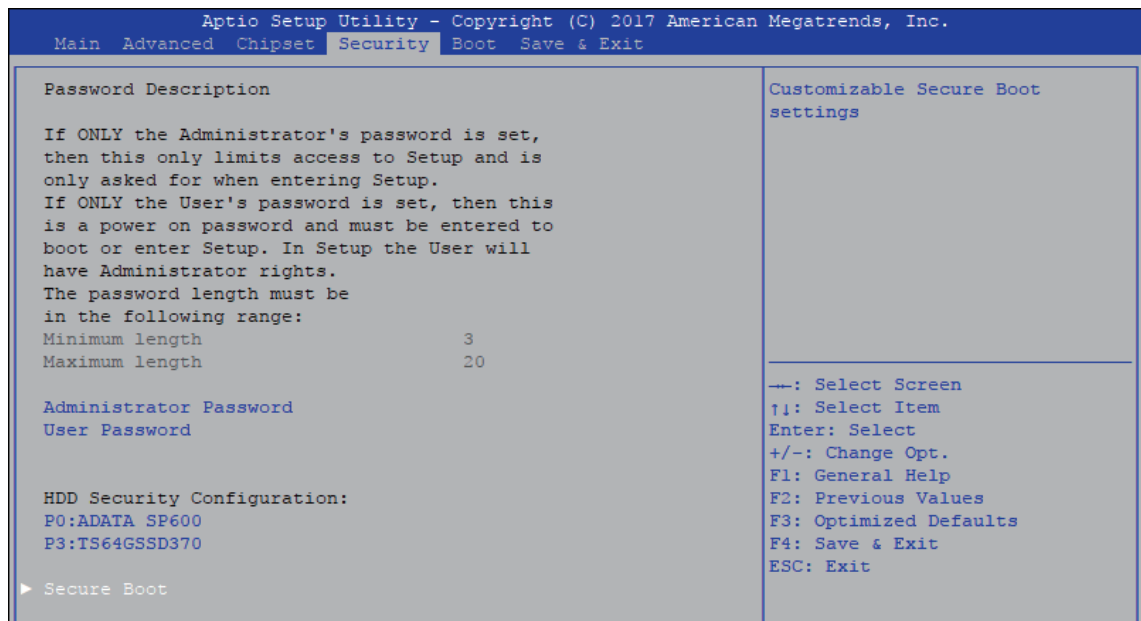

Figure 4-5 : BIOS Security Menu

Administrator Password

Set administrator password.

User Password

Set user password.

Secure Boot

Customizable Secure Boot Settings.

4.5.1 HDD Security Configuration



Figure 4-5-1 HDD Security Settings

Set User Password

Set HDD user password.

*** Advisable to power cycle system after setting hard disk passwords ***

Discard or save changes option in setup does not have any impact on HDD when password is set or removed. If the 'Set HDD User Password' option is gray, do power cycle to enable the option again.

4.5.2 HDD Security Configuration

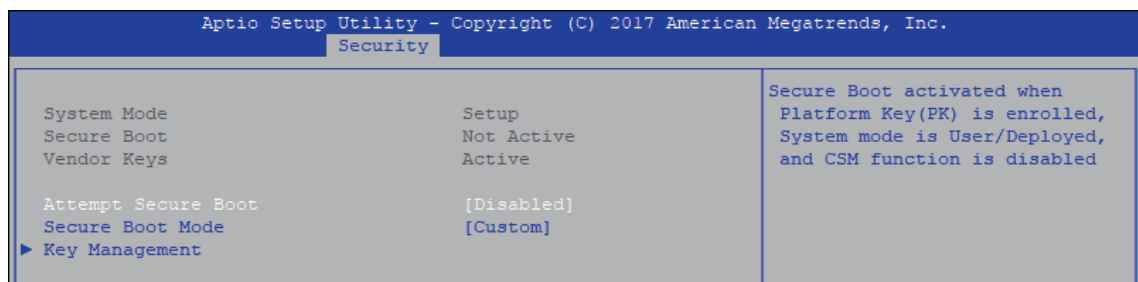

Figure 4-5-2 Security Boot Settings

Attempt Secure Boot

Secure Boot activated when Platform Key (PK) is enrolled, System mode is User/Deployed, and CSM function is disabled.

Secure Boot Mode

Secure Boot mode selector Standard/Custom.

In custom mode Secure Boot Variables can be configured without authentication

Key Management

Enables expert users to modify Secure boot policy variables without full authentication

4.6 Boot

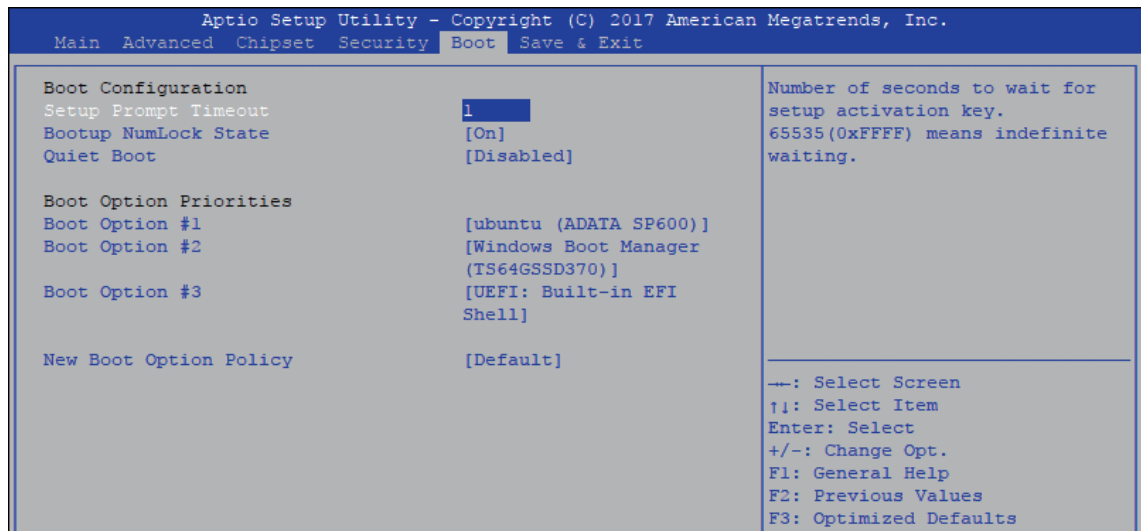

Figure 4-6 : BIOS Boot Menu

Setup Prompt Timeout

Number of seconds to wait for setup activation key. 65535 (0xFFFF) means indefinite waiting.

Bootup NumLock State

Select the keyboard NumLock state.

Quiet Boot

Enables or disables Quiet Boot option.

Boot Option

Sets the system boot order.

New Boot Option Policy

Controls the placement of newly detected UEFI boot options.

Hard Drive BBS Priorities

Set the order of the Legacy devices in this group.

4.7 Save & Exit

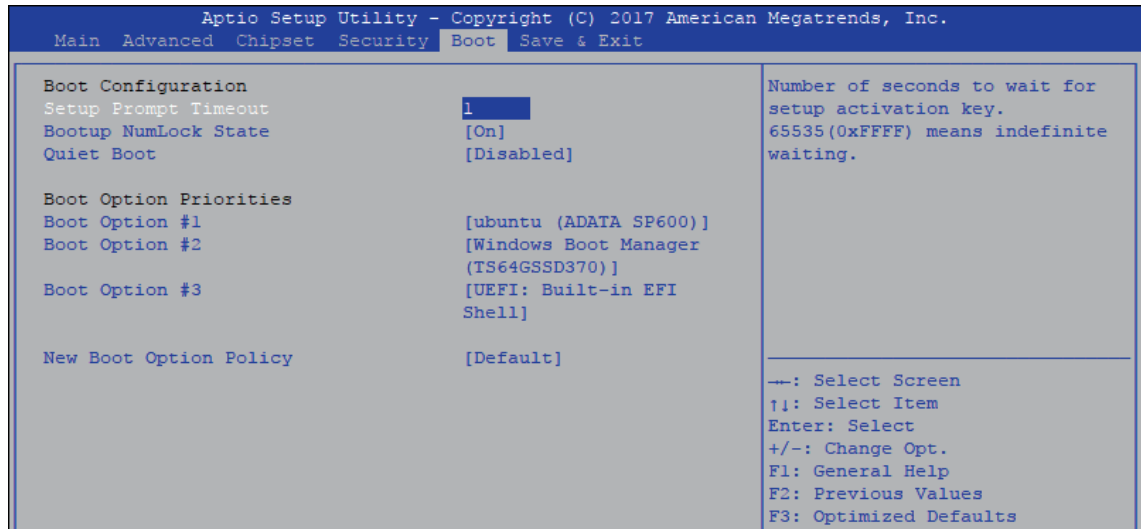

Figure 4-7 : Bios Save and Exit Menu

Save Changes and Exit

Exit system setup after saving the changes.

Discard Changes and Exit

Exit system setup without saving any changes.

Save Changes and Reset

Reset the system after saving the changes.

Discard Changes and Reset

Reset system setup without saving any changes.

Save Changes

Save Changes done so far to any of the setup options.

Discard Changes

Discard Changes done so far to any of the setup options.

A

APPENDIX A : Isolated DIO Guide

A.1 Function Description

The EVS-1000 offers two 16-bit Isolated DIO 20-pin terminal block connector and a watchdog timer.

Isolated DIO pins are fix by Hardware design that cannot change in/out direction in runtime process.

DIO definition is shown below :

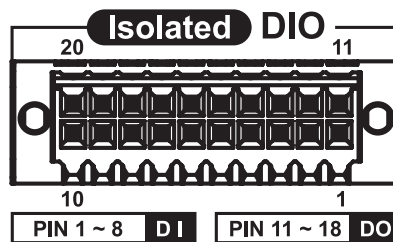

Pin No.	Isolated DIO Definition	Pin No.	Isolated DIO Definition
1	DI 0	11	DO 0
2	DI 1	12	DO 1
3	DI 2	13	DO 2
4	DI 3	14	DO 3
5	DI 4	15	DO 4
6	DI 5	16	DO 5
7	DI 6	17	DO 6
8	DI 7	18	DO 7
9	DI_COM	19	DIO_GND
10	DIO_GND	20	External VDC

A.2 Isolated DIO Signal Circuit

DI Reference Circuit :

Sink Mode (NPN)

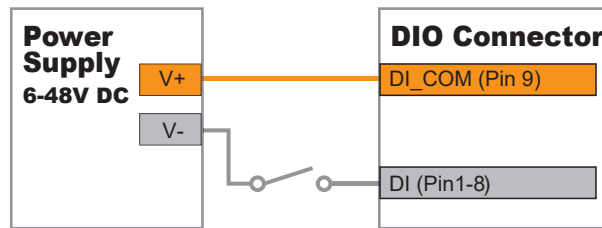

Source Mode (PNP)

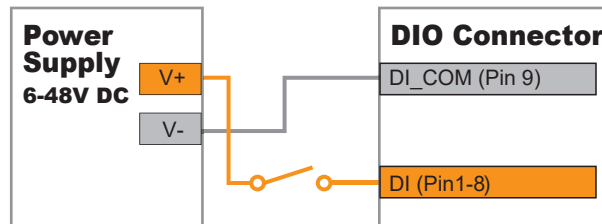

DO Reference Circuit :

Sink Mode
(NPN, Default)

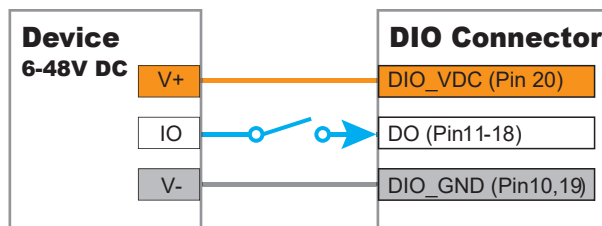

Source Mode
(PNP)

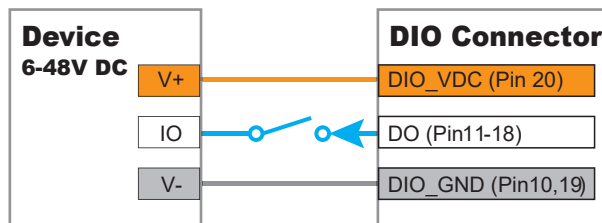

A.3 Isolated DIO Signal Circuit

Distribution folder include x32 and x64 versions, use batch file for installation. There are included as followed :

Win7_32.bat :

Installation for 32-bit driver

Win7_64.bat :

Windows update package which driver required (need to restart), and Installation for 64-bit driver

Win8_32.bat, Win8_64.bat :

Installation for driver, and guideline to Framework 3.5 distribution for sample

Win10_32.bat, and Win10_64.bat

Installation for driver, and installation to Framework 3.5 distribution for sample

Uninstall_32.bat, and Uninstall_64.bat :













Uninstallation for driver

Run batch file as Administrator.

Support Windows 7 above.



Make sure Windows version before installation.

Runtime folder include head file for software developer or System Integration. Sample folder include sample program, driver library, and API library. Source folder include sample program source code that compile on Visual Studio 2008.

-  Distribution
-  Runtime
-  Sample
-  Source
-  Uninstall_32
-  Uninstall_64
-  Win7_32
-  Win7_64
-  Win8_32
-  Win8_64
-  Win10_32
-  Win10_64

A.4 Function Description

Demo tool (EVS1K.exe).

-  drv.dll
-  EVS1K.dll
-  EVS1K

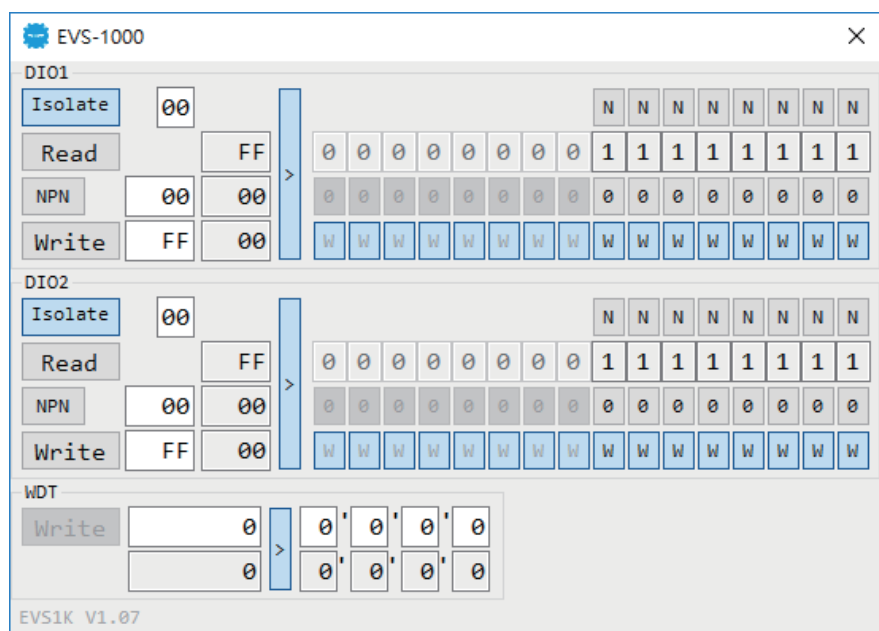

DIO1/DIO2 Group :

Isolate check button :

DIO type of DIO configuration, isolated/non-isolated.

Read button :

Set DIO configuration to get DI/DIO input state.

DO type check button :

User setting, DO type of DIO configuration to setup 8 pins - Source/Sink.

Use for Write (DO) button activate.

Write button :

Set DIO configuration to set DO/DIO output state.

DI preference text :

User setting, DI type of DIO configuration by hexadecimal bitmask - Source/Sink.

Use for Read (DI) button activate.

DO/DIO output text :

User setting, DO/DIO output state by hexadecimal bitmask - on/off.

Use for Write button activate.

DO/DIO writable text :

User setting, DO/DIO writable of DIO configuration by hexadecimal bitmask - yes/no.

Use for Read (DIO)/Write button activate.

DI/DIO input text (read only) :

DI/DIO input state by hexadecimal bitmask – on/off.

Use for Read button activate.

DO/DIO text (read only) :

DO/DIO output state with input state (DIO) and configuration.

Use for Write button activate.

DO/DIO output text (read only) :

DO/DIO output state with configuration.

Use for Write button activate.

DI type pin texts (pin 8 ~ pin 1) :

User setting, DI pin type of DIO configuration - Source/Sink.

DI/DIO input pin texts (read only, pin 8 ~ pin 1/pin 18 ~ pin 11, pin 8 ~ pin 1) :

DI/DIO input pin state

Use for Read button activate.

DO/DIO output pin texts (pin 18 ~ pin 11/pin 18 ~ pin 11, pin 8 ~ pin 1) :

User setting, DO/DIO output pin state

Use for Write button activate.

DO/DIO pin writable texts (pin 18 ~ pin 11/pin 18 ~ pin 11, pin 8 ~ pin 1) :

User setting, DO/DIO pin writable of DIO configuration.

Use for Read (DIO)/Write button activate.

WDT Group :

Write button :

Set WDT when WDT setup text is valid.

Stop button :

Cancel WDT and counting.

Use after Write button action.

WDT setup text :

User setting, WDT value, unit : second.

Use for Write button activate.

WDT counting text (read only) :

WDT counting by program timer after set WDT.

Shown after Write button action.

WDT setup day format texts (user setting) :

User setting, WDT value, format : day'hour'minute'second.

WDT counting day format text (read only) :

WDT counting, format : day'hour'minute'second.

B

APPENDIX B : Software Functions

B.1 Driver API Guide

In Runtime folder, on EVS1K.h :

`_DLL_IMPORT_` definition is used on LoadLibrary API for EVS1K.dll.

`EVS1K_EXPORTS` definition is used on EVS1K.dll building.

Otherwise, that is used to compile with EVS1K.lib

BOOL Initial (BYTE Isolate_Type, BYTE DIO_NPN)

Initial machine for DIO, watchdog timer, and POE

Isolate_Type : DIO type

1 : Isolated DIO;

0 : Non-Isolated DIO

DIO_NPN : DI/DO type

1 : PNP (Source) mode for European rule;

0 : NPN (Sink) mode for Japanese rule

Return :

TRUE (1) : Success;

FALSE (0) : Fail (Driver not exists, or initial error (version is too old, or machine not match))

BOOL GetDIO1Config (BYTE *Isolate_Type, BYTE *DI_NPN, BYTE *DO_NPN, WORD *Mask)

BOOL GetDIO2Config (BYTE *Isolate_Type, BYTE *DI_NPN, BYTE *DO_NPN, WORD *Mask)

Get DIO configuration (by variable)

Isolate_Type : DIO type

1 : Isolated DIO;

0 : Non-Isolated DIO

DI_NPN ([7 : 0]) : DI type, pin setting by hexadecimal bitmask

1 : PNP (Source) mode for European rule;

0 : NPN (Sink) mode for Japanese rule

DO_NPN : DO type

1 : PNP (Source) mode for European rule;

0 : NPN (Sink) mode for Japanese rule

Mask ([15 : 0]) : In/Out, pin setting by hexadecimal bitmask

1 : Output;

0 : Input

Return :

TRUE (1) : Success;

FALSE (0) : Fail (Initial error, or call by pointer error, or hardware problem)

BOOL SetDIO1Config (BYTE *Isolate_Type, BYTE *DI_NPN, BYTE *DO_NPN, WORD *Mask)

BOOL SetDIO2Config (BYTE *Isolate_Type, BYTE *DI_NPN, BYTE *DO_NPN, WORD *Mask)

Set DIO configuration

Isolate_Type : DIO type

1 : Isolated DIO;

0 : Non-Isolated DIO

DI_NPN ([7 : 0]) : DI type, pin setting by hexadecimal bitmask

1 : PNP (Source) mode for European rule;

0 : NPN (Sink) mode for Japanese rule

DO_NPN : DO type

1 : PNP (Source) mode for European rule;

0 : NPN (Sink) mode for Japanese rule

Mask ([15 : 0]) : In/Out, pin setting by hexadecimal bitmask

1 : Output;

0 : Input

Return :

TRUE (1) : Success;

FALSE (0) : Fail (Initial error, or hardware problem)

BOOL GetDI1 (BYTE *DI)

BOOL GetDI2 (BYTE *DI)

Get isolated DIO input (DI)

DI ([7 : 0]) : Input state, pin setting by hexadecimal bitmask

1 : High;

0 : Low

Return :

TRUE (1) : Success;

FALSE (0) : Fail (Initial error, or call by pointer error, or hardware problem)

BOOL GetDO1 (BYTE *DO)

BOOL GetDO2 (BYTE *DO)

Get isolated DIO output (DO)

DO ([7 : 0]) : Output state, pin setting by hexadecimal bitmask

1 : High;

0 : Low

Return :

TRUE (1) : Success;

FALSE (0) : Fail (Initial error, or call by pointer error, or hardware problem)

BOOL SetDO1 (BYTE DO)

BOOL SetDO2 (BYTE DO)

Set isolated DIO output (DO)

DO ([7 : 0]) : Output state, pin setting by hexadecimal bitmask

1 : High;

0 : Low

Return :

TRUE (1) : Success;
FALSE (0) : Fail (Initial error, or hardware problem)

BOOL GetDIO1 (WORD *DI)

BOOL GetDIO2 (WORD *DI)

Get non-isolated DIO input (DIO input)

DI ([15 : 0]) : Input state, pin setting by hexadecimal bitmask

1 : High;

0 : Low

Return :

TRUE (1) : Success;

FALSE (0) : Fail (Initial error, or call by pointer error, or hardware problem)

BOOL SetDIO1 (WORD DO)

BOOL SetDIO2 (WORD DO)

Set non-isolated DIO output (DIO output)

DO ([15 : 0]) : output state, pin setting by hexadecimal bitmask

1 : High;

0 : Low

Return :

TRUE (1) : Success;

FALSE (0) : Fail (Initial error, or hardware problem)

BOOL GetWDT (DWORD *WDT)

Get watchdog timer setup

WDT : watchdog timer setup

Unit : second. (Range : 0 ~ 65535 sec, 1093 ~ 65535 min (=65580 ~ 3932100 sec))

Return :

TRUE (1) : Success;

FALSE (0) : Fail (Initial error, or call by pointer error, or hardware problem)

BOOL SetWDT (DWORD WDT)

Set watchdog timer setup

WDT : watchdog timer setup

Unit : second. (Range : 1 ~ 65535 sec, 1093 ~ 65535 min (=65580 ~ 3932100 sec))

Return :

TRUE (1) : Success;

FALSE (0) : Fail (Initial error, or setup 0 error, or hardware problem)

BOOL CancelWDT ()

Cancel watchdog timer

Return :

TRUE (1) : Success;

FALSE (0) : Fail (Initial error, or hardware problem)



APPENDIX C : RAID Installation Guide

C.1 SATA Mode for RAID

C.1.1 SATA Mode for RAID

Please select SATA device to RAID mode on BIOS menu.

Advanced → SATA Configuration → SATA Mode Selection → RAID (Skylake platform)/Intel RST Premium (Kaby Lake platform)

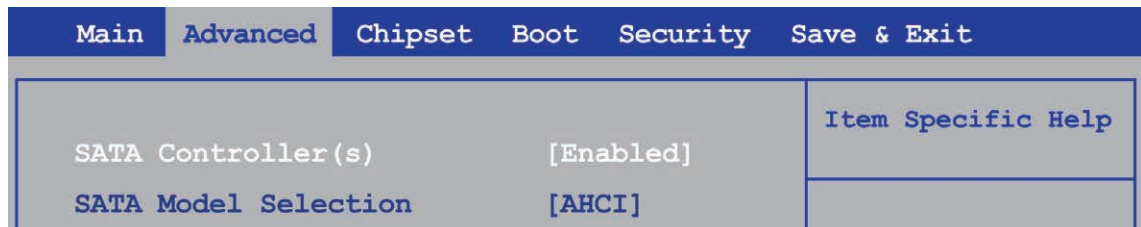

C.1.2 UEFI Mode for RAID

1. Please select SATA device to RAID mode on BIOS menu.
Advanced → SATA Configuration → SATA Mode Selection → RAID (Skylake platform)/Intel RST Premium (Kaby Lake platform)
2. Please select Software Feature Mask Configuration on BIOS menu.

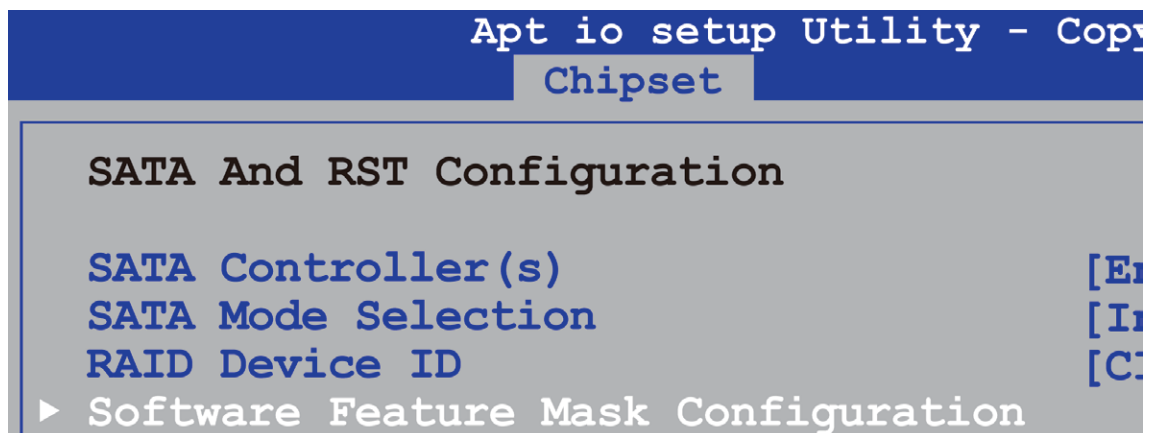

3. Use RST Legacy → Disabled → Save Changes and Reset.

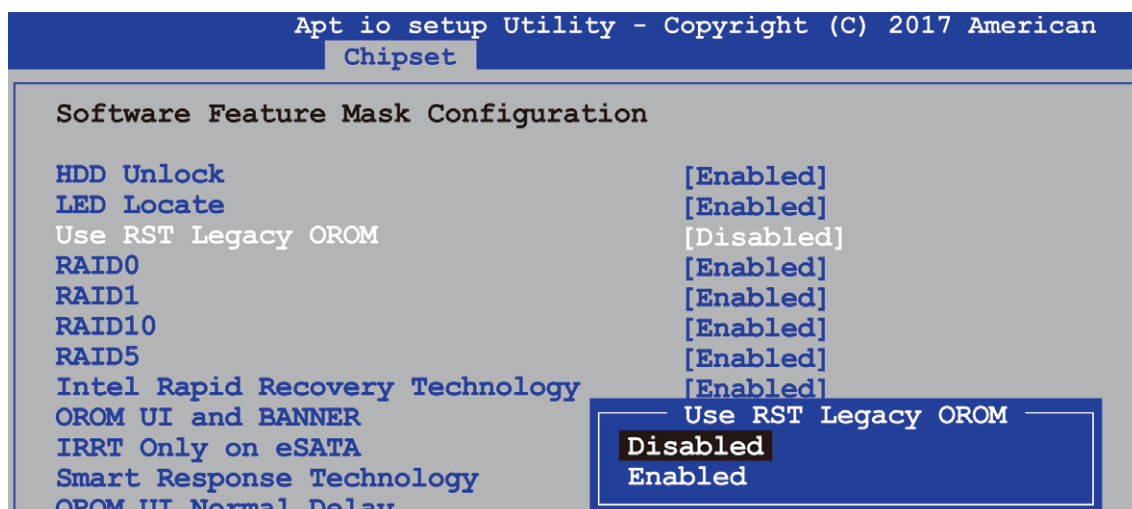

4. Into BIOS menu again, select Intel (R) Rapid Storage Technology on BIOS menu.

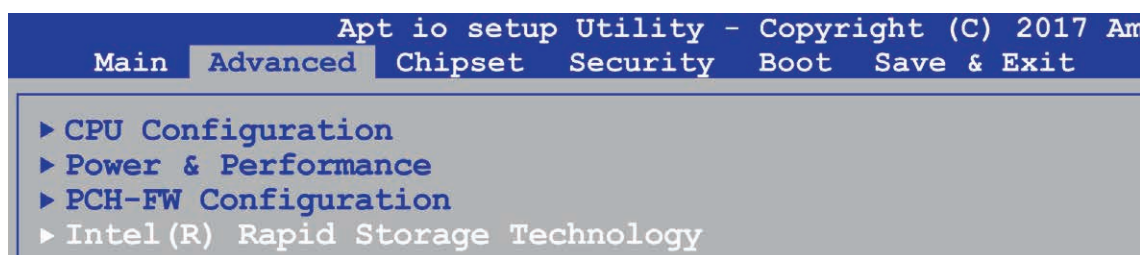

5. Select Create RAID Volume on BIOS menu.

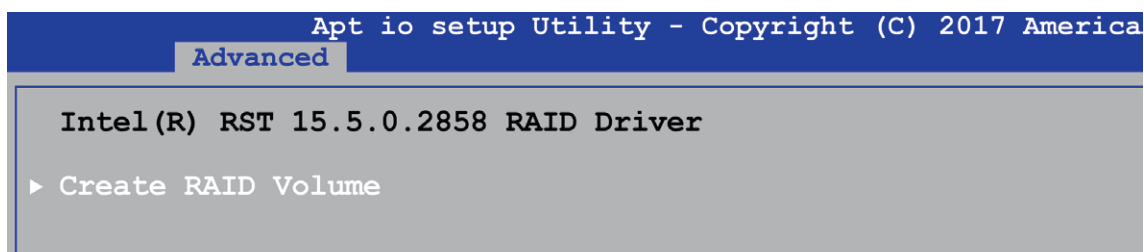

6. Select disks to create RAID Volume then Save Changes and Reset to install OS with EFI mode.

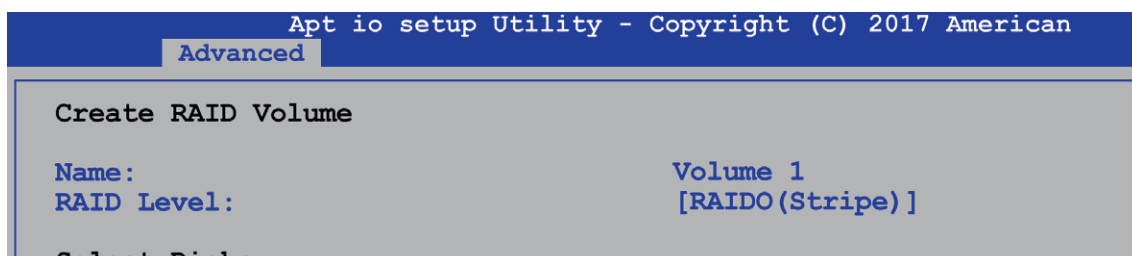

C.2 OS Installation

ARS-2000 is featured with two SATA, including two internal SATA. We used SATA for Windows 10 OS installation as an example.

C.3 To Install All Device Drivers of the System

The instructions are as follows :

1. Install Chipset driver
2. Install Network driver
3. Install ME driver (if available)
4. Install Audio driver
5. Install VGA driver

C.4 To Install "Intel Rapid Storage Technology" Software

You can get the latest information and the software directly from Intel website.

http://www.intel.com/p/en_US/support/highlights/chpsts/imsm

The RAID environment has been done if you completed the steps above.

C.5 To Insert SATA HDD for RAID 1

Please note, you can use two SATA ports for SATA HDD, except for mSATA slot.

C.6 To Create RAID Volume on "Rapid Storage Technology" Software

ARS-2000 is featured with two SATA HDD's for RAID volume, so there are two options to choose on this page. Let's take RAID 1 as an example, select "RAID 1".

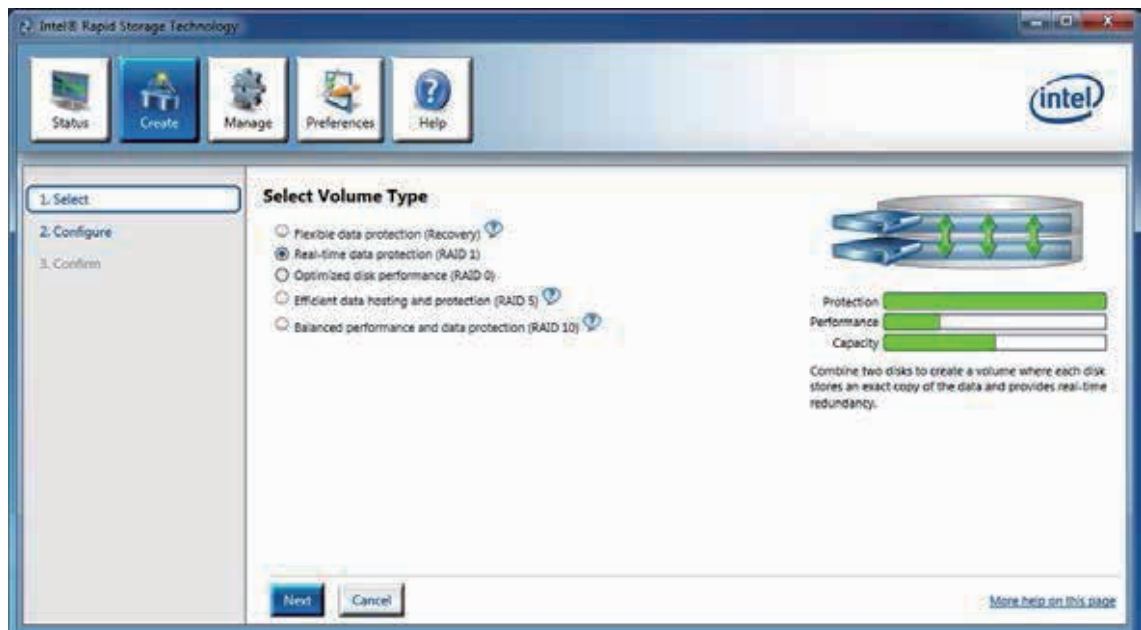

C.7 Disk Management : Partition the Disk

After RAID 1 volume is created, you can see the figure of SATA device allocation.

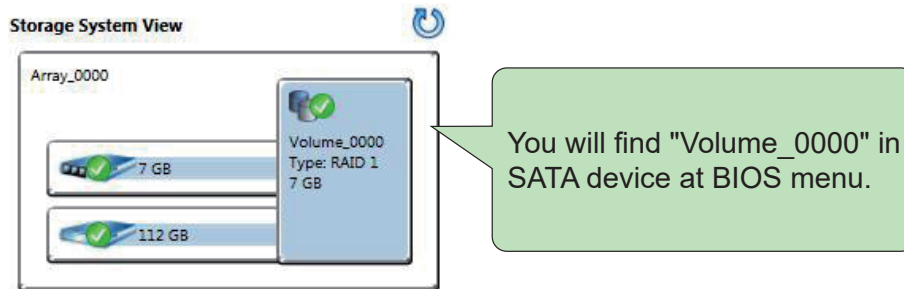

To start disk management tool, select "initialize disk".

Then add "Logical Device" for Windows access.

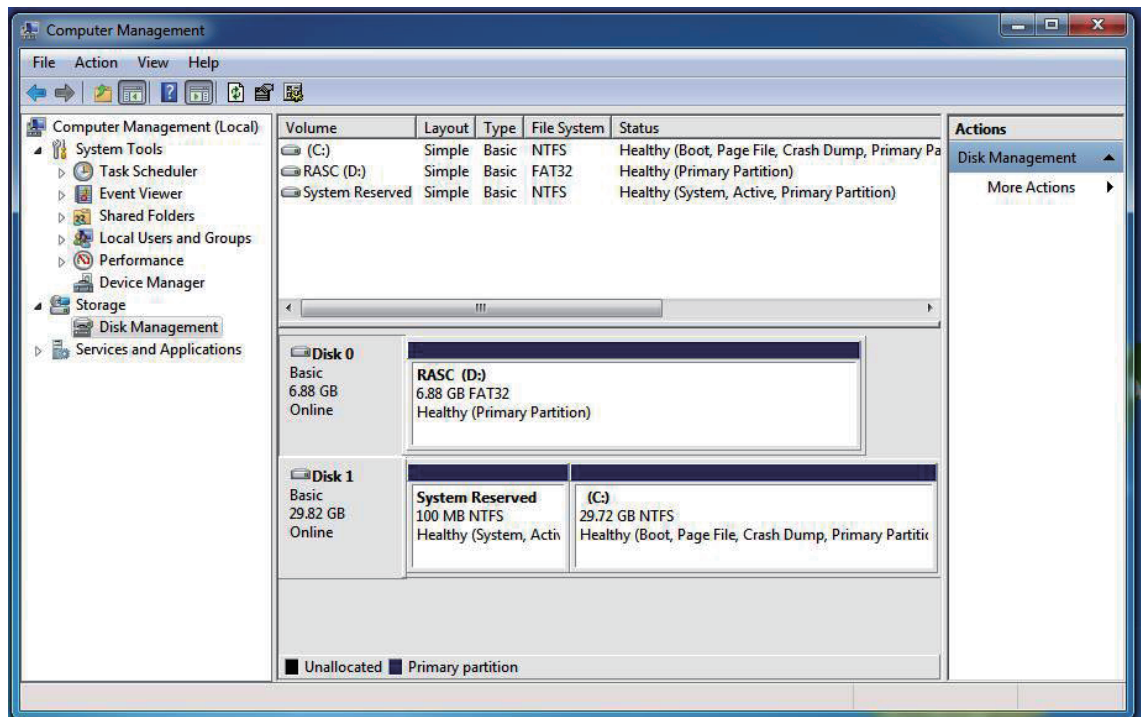

C.8 If One SATA HDD on RAID Volume is Out-of-use

After RAID 1 volume is created, you can see the figure of SATA device allocation.

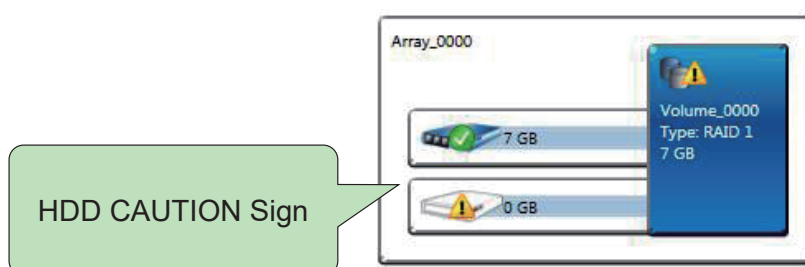

C.9 Recovery and Auto Re-build When Using the SAME RAID HDD

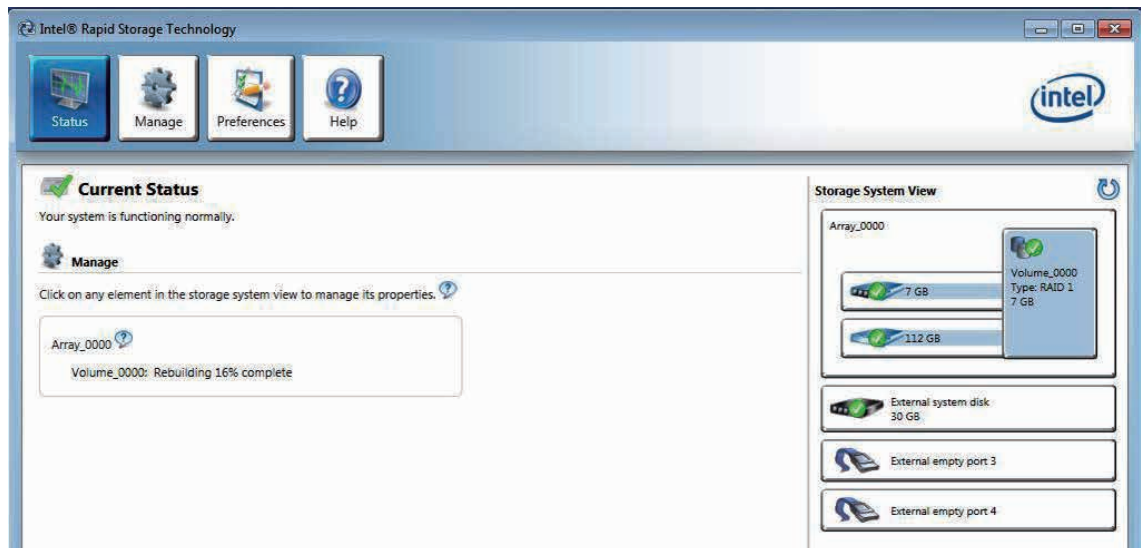

C.10 Recovery and Auto Re-build When Using DIFFERENT RAID HDD

A warning will pop-up to ask you if the disk is not a member of the original RAID volume.

If you press "Rebuild", it will replace the broken SATA HDD to the last SATA HDD of RAID volume.

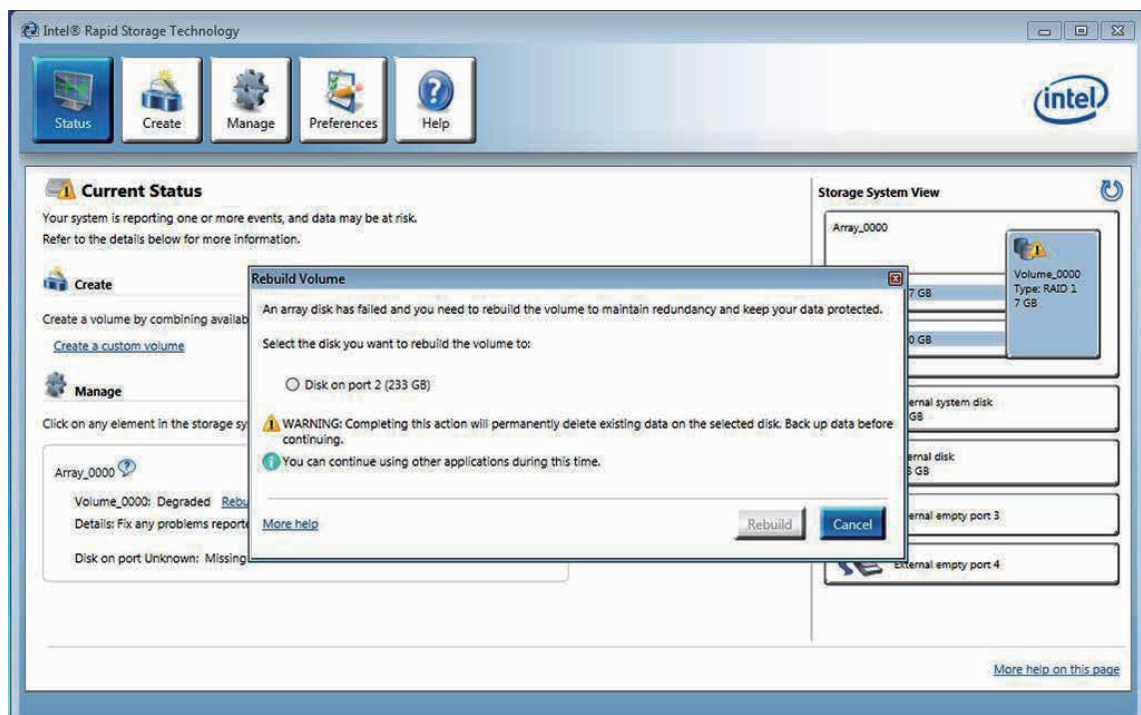

D

APPENDIX D : Supported Memory & Storage List

D.1 Supported Memory List

Testing Board	EVS-1000
CPU	i7-6700TE
Memory Test	Version : 5.1
BurnInTest	V 8.1

D.2 Test Item

Channel	Memory Test	Burn In	Flash BIOS	Remove Battery
*2	PASS	PASS	PASS	PASS
*1 (Socket 1)	PASS	PASS	N/A	PASS
*1 (Socket 2)	PASS	PASS	N/A	PASS

D.3 NON-ECC

Brand	Info	Test Temp. (Celsius)
Transcend 8GB 2Rx8 DDR4 2133 SO	TS9CASESE0000	25°C
		25°C
Transcend 16GB 16G 2Rx8 DDR4 2133 SO	TS0CASGSB0000	25°C
		25°C
Transcend 16GB 16G 2Rx8 DDR4 2133 SO Wide Temperature	TS0CASGSB0000	25°C
		25°C
Kingston 4GB 1Rx8 512M x 64-bit PC4- 2133 CL15 260-pin SODIMM	KVR21S15S8/4	25°C
		25°C
Kingston 4GB 1Rx8 512M x 64-bit PC4-2400 CL17 260-pin SODIMM	KVR24S17S8/4	25°C
		25°C
Kingston 8GB 1Rx8 1G x 64-bit PC4-2133 CL15 260-pin SODIMM	KVR21S15S8/8	25°C
		25°C
Kingston 8GB 1Rx8 1G x 64-bit PC4-2400 CL17 260-pin SODIMM	KVR24S17S8/8	25°C
		25°C
Kingston 16GB 2Rx8 2G x 64-bit PC4-2133 CL15 260-pin SODIMM	KVR21S15D8/16	25°C
		25°C
Kingston 16GB 2Rx8 2G x 64-bit PC4-2400 CL17 260-pin SODIMM	KVR24S17D8/16	25°C
		25°C
Innodisk 4GB DDR4 2133 SODIMM	M4S0-4GSSNCRG	25°C
		25°C
Innodisk 4GB DDR4 2400 SODIMM	M4S0-4GSSNCSJ	25°C
		25°C
Innodisk 8GB DDR4 2133 SODIMM	M4S0-8GSSOCR	25°C
		25°C
Innodisk 8GB DDR4 2400 SODIMM	M4S0-8GSSOCSJ	25°C
		25°C
Innodisk 16GB DDR4 2133 SODIMM	M4S0-AGS1OCR	25°C
		25°C
TLA 4GB 260PIN DDR4-2400 (SAMSUNG K4A8G165WB-BCRC)	AD4SSZ4GT2WB-FQGB	25°C
		25°C
TLA 8GB 260PIN DDR4-2400 (SAMSUNG K4A8G165WB-BCRC)	AD4SSZ8GT6WB-FQGB	25°C
		25°C

D.4 Supported Storage Device List

Type	Brand	Model	Capacity
mSATA	Innodisk	mSATA 3ME DEMSR-32GD06SW2QC	32GB
	Intel	Intel-310 SSDMAEMC080G2	80GB
SATA SSD	MEMXPRO	SSD 540s SSDSC2KW180H6	180GB
		SSD 540s SSDSC2KW120H6	120GB
		SSD E 5400s SSDSC2KR120H6	120GB
		SSD 530 SSDSC2BW120A4	120GB
	LITE-ON	K8-L1512	512GB
		K8-L1256	256GB
SATA HDD	Seagate	6VDBY095	160GB
CFast	Transcend	TS64GCFX600	64GB

** If more help is needed, please contact Vecow Technical Support. **

E

APPENDIX E : Graphics Benchmark

E.1 Intel® Core™ i7-6700TE (8M Cache, 2.4 GHz) with GT 1030

Test Temperature (based on 95% Humidity)	30°C	35°C	40°C	45°C	50°C	55°C	60°C
3DMARK (V2-4-3819)							
Score	1160	1160	1158	1154	1151	1147	1068
Graphics score	1043	1042	1040	1037	1035	1030	956
Resolution	1920 x 1080						
Highest Temperature	55°C	59°C	68°C	74°C	78°C	83°C	84°C
Power Status							
On	PASS	PASS	PASS	PASS	PASS	PASS	PASS
Off	PASS	PASS	PASS	PASS	PASS	PASS	PASS

E.2 Intel® Core™ i7-6700TE (8M Cache, 2.4 GHz) with GTX 1070

Test Temperature (based on 95% Humidity)	30°C	35°C	40°C	45°C	50°C	55°C	60°C
3DMARK (V2-4-3819)							
Score	4725	4676	4562	4492	4025	3794	3209
Graphics score	5131	5088	4933	4835	4213	3916	3217
Resolution	1920 x 1080						
Highest Temperature	74°C	78°C	89°C	91°C	91°C	91°C	91°C
Power Status							
On	PASS	PASS	PASS	PASS	PASS	PASS	PASS
Off	PASS	PASS	PASS	PASS	PASS	PASS	PASS

F

APPENDIX F : Install Win11 (BIOS TPM Setting)

Step 1 Click on “Advanced”, then click on “PCH-FW Configuration”

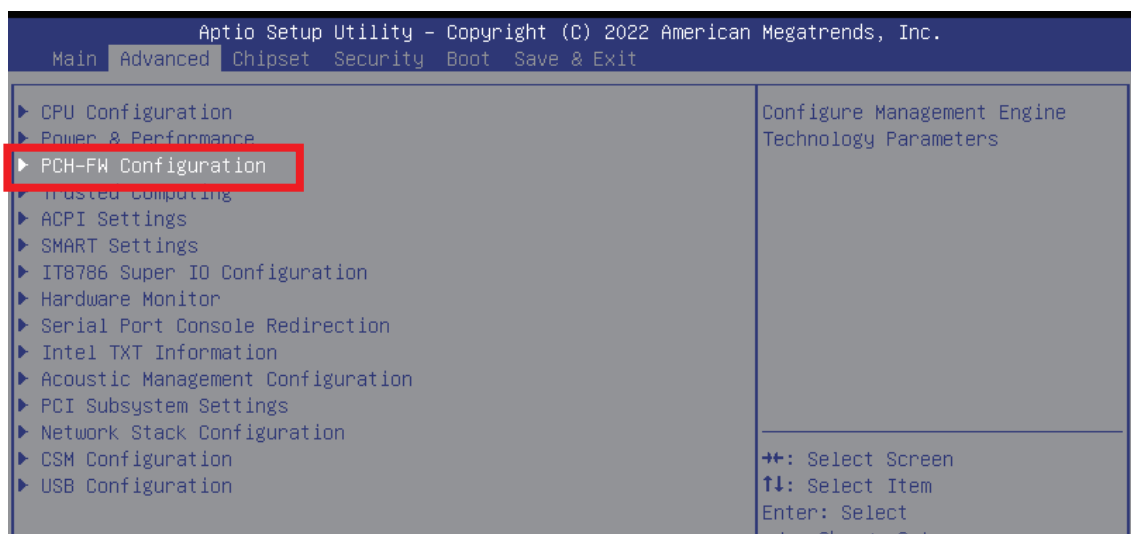

Step 2 Click on “PTT Configuration”

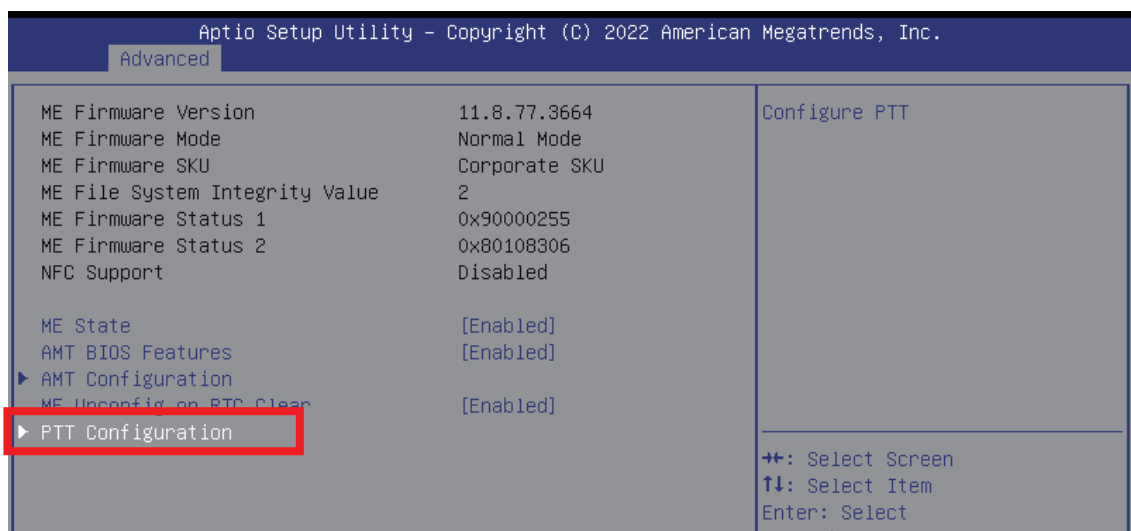

Step 3 Click on “dTPM” (TPM Device Selection)

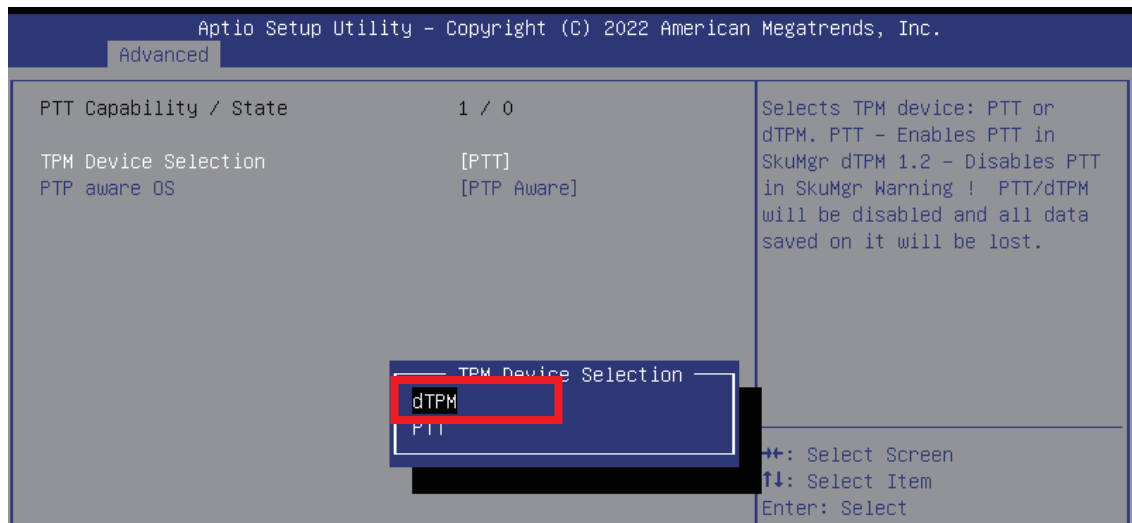

Step 4 Please save the BIOS settings by pressing F4. Please press Enter when the pop-up window which asks “Save configuration and exit?” appears. The computer will then restart.

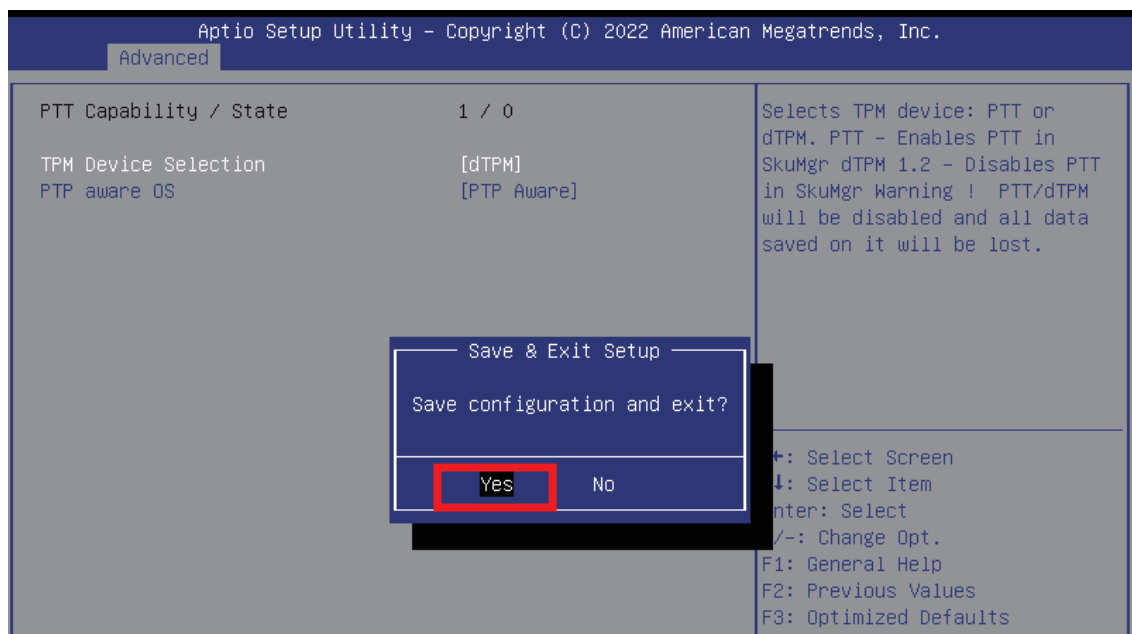

Step 5 Click on “Trusted Computing”

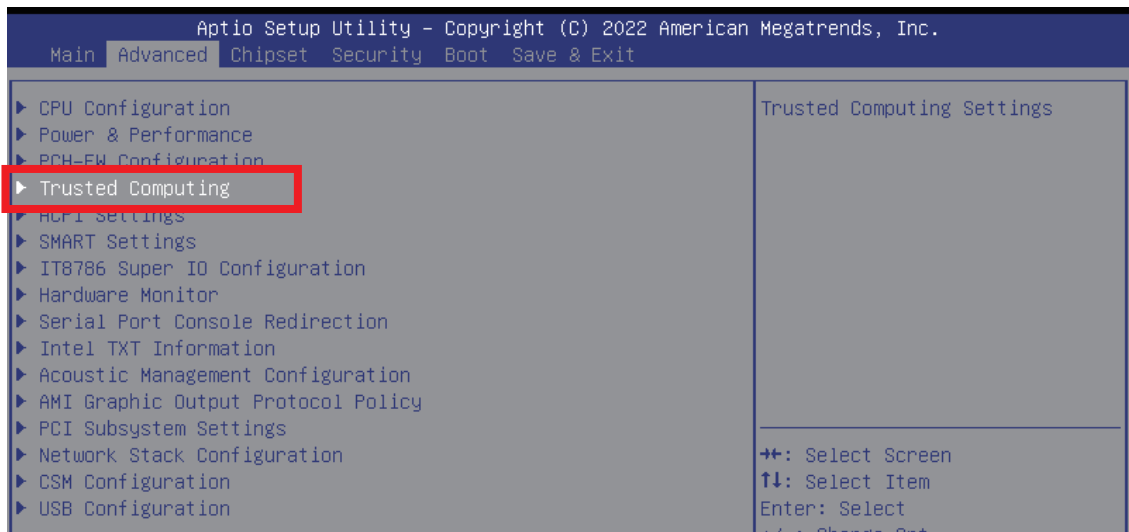

Step 6 If the window shows “TPM2.0 Device Found Firmware Version:5.62”, then the setting is completed.

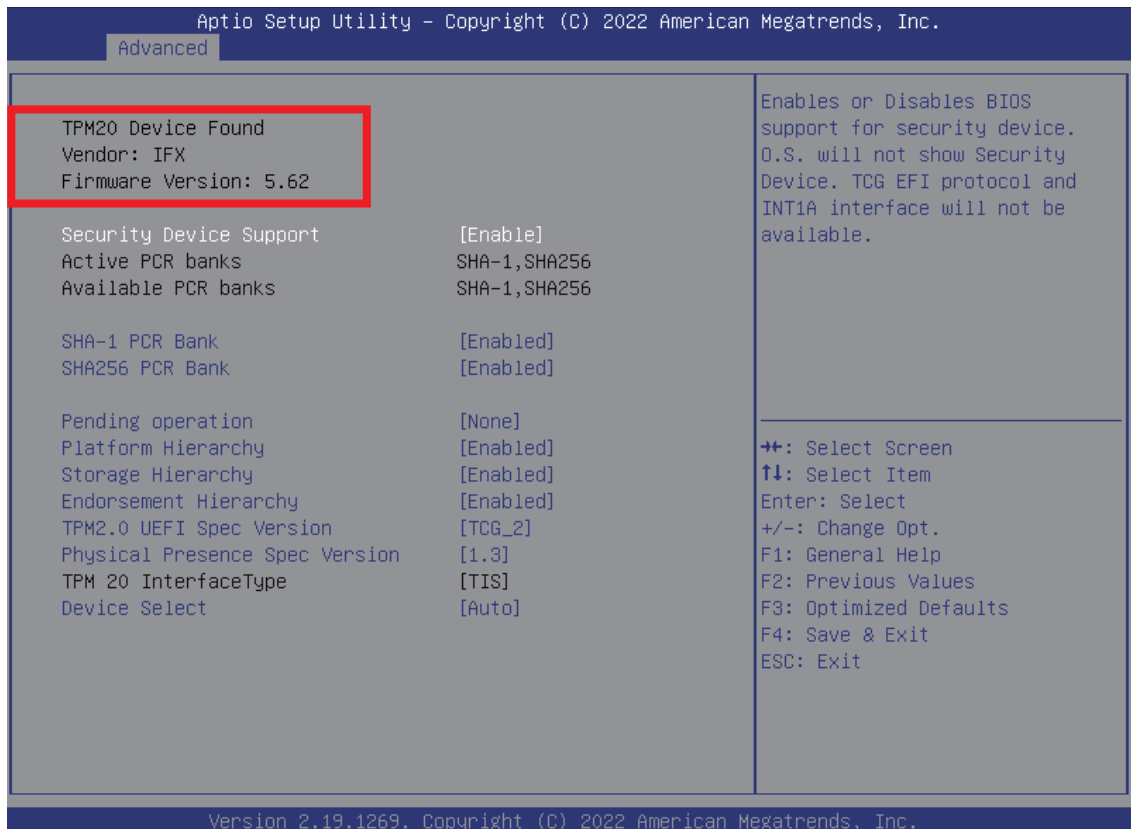

** If more help is needed, please contact Vecow technical support **



For further support information, please visit www.vecow.com

This document is released for reference purpose only.

All product offerings and specifications are subject to change without prior notice.

No part of this publication may be reproduced in any form or by any means, electric, photocopying, or recording, without prior authorization from the publisher.

The rights of all the brand names, product names, and trademarks belong to their respective owners.

© Vecow Co., Ltd. 2018. All rights reserved.